

## Aluminum Electrolytic Capacitors Axial Miniature, Long-Life

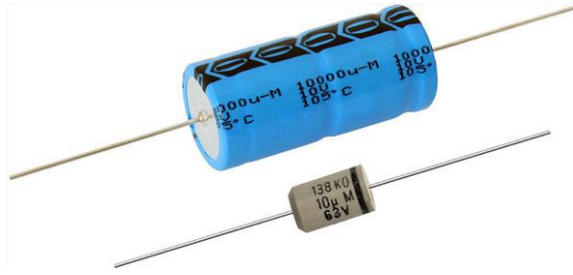


Fig. 1

| QUICK REFERENCE DATA                               |                                   |                                   |
|--|-----------------------------------|-----------------------------------|
| DESCRIPTION  | VALUE                             |                                   |
| Nominal case sizes<br>( $\varnothing$ D x L in mm) | 6.3 x 12.7<br>to 10 x 25          | 10 x 30<br>to 21 x 38             |
| Rated capacitance range, $C_R$                     | 2.2 $\mu$ F to 15 000 $\mu$ F     |                                   |
| Tolerance on $C_R$                                 | $\pm 20\%$                        |                                   |
| Rated voltage range, $U_R$                         | 6.3 V to 100 V                    |                                   |
| Category temperature range                         | -40 °C to +105 °C                 |                                   |
| Endurance test at 105 °C                           | 1000 h                            | 5000 h                            |
| Useful life at 105 °C                              | 2000 h                            | 10 000 h                          |
| Useful life at 40 °C,<br>$I_R$ applied             | 1.3 x $I_R$ applied:<br>200 000 h | 1.8 x $I_R$ applied:<br>500 000 h |
| Shelf life at 0 V, 105 °C                          | 500 h                             |                                   |
| Based on sectional<br>specification                | IEC 60384-4 / EN130 300           |                                   |
| Climatic category IEC 60068                        | 40 / 105 / 56                     |                                   |

### FEATURES

- Polarized aluminum electrolytic capacitors, non-solid electrolyte
- Axial leads, cylindrical aluminum case, insulated with a blue sleeve (case  $\varnothing$  6.3 mm x 12.7 mm and 7.7 mm x 12.7 mm are molded with flame retardant plastic material)
- Mounting ring version not available in insulated form
- Taped versions up to case  $\varnothing$  15 mm x 30 mm available for automatic insertion
- Charge and discharge proof
- Long useful life: 2000 h to 10 000 h at 105 °C, high reliability
- High ripple current capability
- Miniaturized, high CV-product per unit volume
- Material categorization: for definitions of compliance please see [www.vishay.com/doc?99912](http://www.vishay.com/doc?99912)


**RoHS  
COMPLIANT**

### APPLICATIONS

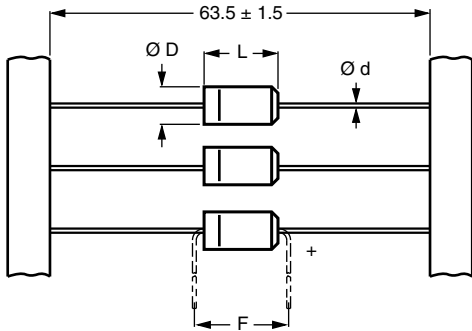
- Industrial, automotive, EDP and telecommunication
- Smoothing, filtering, buffering in SMPS; coupling, decoupling, timing
- Portable and mobile equipment (small size, low mass)
- Stand-by applications
- Low mounting height boards, vibration and shock resistant

### MARKING

The capacitors are marked (where possible) with the following information:

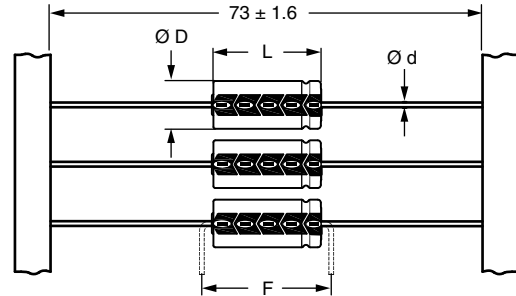
- Rated capacitance (in  $\mu$ F)
- Tolerance on rated capacitance, code letter in accordance with IEC 60062 (M for  $\pm 20\%$ )
- Rated voltage (in V)
- Upper category temperature (105 °C)
- Date code, in accordance with IEC 60062
- Code for factory of origin
- Name of manufacturer
- Negative terminal identification
- Series number (138)

| SELECTION CHART FOR $C_R$ , $U_R$ , AND RELEVANT NOMINAL CASE SIZES ( $\varnothing D \times L$ in mm) |            |            |            |            |            |            |            |            |
|---|------------|------------|------------|------------|------------|------------|------------|------------|
| $C_R$<br>( $\mu F$ )  | $U_R$ (V)  |            |            |            |            |            |            |            |
|   | 6.3        | 10         | 16         | 25         | 40         | 50         | 63         | 100        |
| 2.2   | -          | -          | -          | -          | -          | -          | -          | 6.3 x 12.7 |
| 4.7   | -          | -          | -          | -          | -          | -          | 6.3 x 12.7 | 7.7 x 12.7 |
| 10  | -          | -          | -          | 6.3 x 12.7 | -          | 6.3 x 12.7 | 7.7 x 12.7 | 6.5 x 18   |
| 22  | -          | -          | 6.3 x 12.7 | 6.3 x 12.7 | -          | 7.7 x 12.7 | 6.5 x 18   | 8 x 18     |
| 33  | -          | -          | -          | -          | 7.7 x 12.7 | -          | -          | -          |
| 47  | -          | -          | 6.3 x 12.7 | 7.7 x 12.7 | 6.5 x 18   | -          | 8 x 18     | 10 x 25    |
| 68  | -          | -          | -          | -          | -          | -          | -          | 10 x 30    |
| 100   | 6.3 x 12.7 | -          | 7.7 x 12.7 | 6.5 x 18   | 8 x 18     | 10 x 18    | 10 x 25    | 12.5 x 30  |
| 150   | -          | 7.7 x 12.7 | -          | -          | -          | -          | 10 x 30    | 15 x 30    |
| 220   | 7.7 x 12.7 | 6.5 x 18   | 8 x 18     | 10 x 18    | 10 x 25    | -          | 12.5 x 30  | 15 x 30    |
| 330   | -          | -          | -          | -          | 10 x 30    | -          | 12.5 x 30  | 18 x 30    |
| 470   | 6.5 x 18   | 8 x 18     | 10 x 18    | 10 x 25    | 12.5 x 30  | -          | 15 x 30    | 18 x 38    |
| 680   | -          | -          | -          | 10 x 30    | 12.5 x 30  | -          | 18 x 30    | 21 x 38    |
| 1000  | 10 x 18    | 10 x 25    | 10 x 30    | 12.5 x 30  | 15 x 30    | -          | 18 x 38    | -          |
| 1500  | -          | 10 x 30    | 12.5 x 30  | 15 x 30    | 18 x 30    | -          | 21 x 38    | -          |
| 2200  | 10 x 25    | 12.5 x 30  | 15 x 30    | 18 x 30    | 18 x 38    | -          | -          | -          |
| 3300  | -          | 15 x 30    | 18 x 30    | 18 x 38    | 21 x 38    | -          | -          | -          |
| 4700  | -          | 18 x 30    | 18 x 30    | 18 x 38    | -          | -          | -          | -          |
| 6800  | -          | 18 x 38    | 18 x 38    | 21 x 38    | -          | -          | -          | -          |
| 10 000  | -          | 18 x 38    | 21 x 38    | -          | -          | -          | -          | -          |
| 15 000  | -          | 21 x 38    | -          | -          | -          | -          | -          | -          |

**DIMENSIONS in millimeters AND AVAILABLE FORMS**


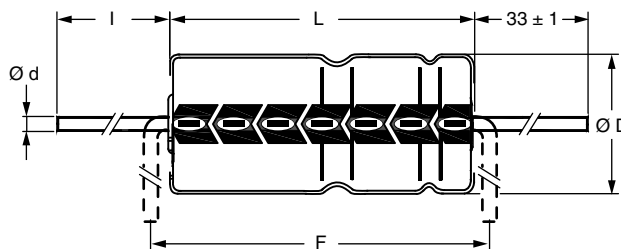
**Form BR:** Taped on reel  
**Form BA:** Taped in box (ammopack)  
 Case  $\varnothing D \times L = 6.3 \text{ mm} \times 12.7 \text{ mm}$  to  $7.7 \text{ mm} \times 12.7 \text{ mm}$

Fig. 2 - Forms BA and BR



**Form BR:** Taped on reel  
 Case  $\varnothing D \times L = 6.5 \text{ mm} \times 18 \text{ mm}$  to  $15 \text{ mm} \times 30 \text{ mm}$   
**Form BA:** Taped in box (ammopack)  
 Case  $\varnothing D \times L = 6.5 \text{ mm} \times 18 \text{ mm}$  to  $10 \text{ mm} \times 25 \text{ mm}$

Fig. 3 - Forms BA and BR



**Form AA:** Axial in box  
 Case  $\varnothing D \times L = 10 \text{ mm} \times 30 \text{ mm}$  to  $21 \text{ mm} \times 38 \text{ mm}$

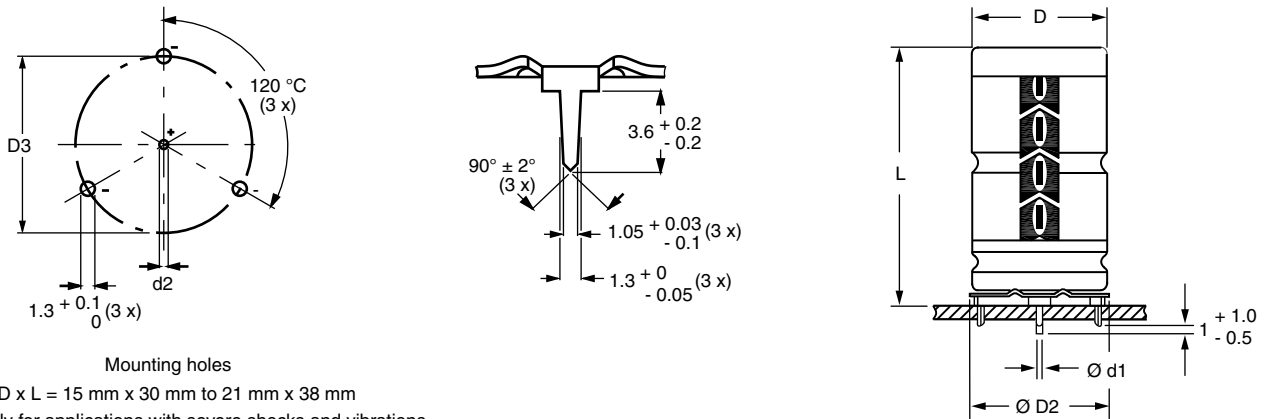
Fig. 4 - Form AA

**Table 1**

| <b>AXIAL; DIMENSIONS</b> in millimeters, <b>MASS AND PACKAGING QUANTITIES</b> |           |                            |        |                     |                   |                   |          |                      |         |         |
|---|-----------|----------------------------|--------|---------------------|-------------------|-------------------|----------|----------------------|---------|---------|
| NOMINAL CASE SIZE<br>Ø D x L<br>(mm)  | CASE CODE | AXIAL: FORM AA, BA, AND BR |        |                     |                   |                   | MASS (g) | PACKAGING QUANTITIES |         |         |
|   |           | Ø d                        | l      | Ø D <sub>max.</sub> | L <sub>max.</sub> | F <sub>min.</sub> |          | FORM AA              | FORM BA | FORM BR |
| 6.3 x 12.7  | (2)       | 0.6                        | -      | 6.5                 | 12.9              | 17.5              | ≈ 1.1    | -                    | 1000    | 1000    |
| 7.7 x 12.7  | (3)       | 0.6                        | -      | 7.9                 | 12.9              | 17.5              | ≈ 1.3    | -                    | 500     | 500     |
| 6.5 x 18  | 4         | 0.8                        | -      | 6.9                 | 18.5              | 25                | ≈ 1.3    | -                    | 1000    | 1000    |
| 8 x 18  | 5         | 0.8                        | -      | 8.5                 | 18.5              | 25                | ≈ 1.7    | -                    | 500     | 500     |
| 10 x 18   | 6         | 0.8                        | -      | 10.5                | 18.5              | 25                | ≈ 2.5    | -                    | 500     | 500     |
| 10 x 25   | 7         | 0.8                        | -      | 10.5                | 25.5              | 30                | ≈ 3.3    | -                    | 500     | 500     |
| 10 x 30   | 00        | 0.8                        | 55 ± 1 | 10.5                | 30.5              | 35                | ≈ 4.8    | 340                  | -       | 500     |
| 12.5 x 30   | 01        | 0.8                        | 55 ± 1 | 13.0                | 30.5              | 35                | ≈ 7.4    | 260                  | -       | 400     |
| 15 x 30   | 02        | 0.8                        | 55 ± 1 | 15.5                | 30.5              | 35                | ≈ 11.7   | 200                  | -       | 250     |
| 18 x 30   | 03        | 0.8                        | 55 ± 1 | 18.5                | 30.5              | 35                | ≈ 12.9   | 120                  | -       | -       |
| 18 x 38   | 04        | 0.8                        | 34 ± 1 | 18.5                | 39.5              | 44                | ≈ 19.0   | 125                  | -       | -       |
| 21 x 38   | 05        | 0.8                        | 34 ± 1 | 21.5                | 39.5              | 44                | ≈ 24.0   | 100                  | -       | -       |

**Note**

- For detailed tape dimensions refer to packaging information: [www.vishay.com/doc?28361](http://www.vishay.com/doc?28361)


 Fig. 5 - Mounting hole diagram and outline; **Form MR:** With mounting ring and pins

**Table 2**

| <b>MOUNTING RING; DIMENSIONS</b> in millimeters, <b>MASS AND PACKAGING QUANTITIES</b> |           |                        |           |                   |                      |            |                   |          |                      |
|---|-----------|------------------------|-----------|-------------------|----------------------|------------|-------------------|----------|----------------------|
| NOMINAL CASE SIZE<br>Ø D x L  | CASE CODE | MOUNTING RING: FORM MR |           |                   |                      |            |                   | MASS (g) | PACKAGING QUANTITIES |
|   |           | Ø d1                   | Ø d2      | D <sub>max.</sub> | Ø D <sub>2max.</sub> | D3         | L <sub>max.</sub> |          |                      |
| 15 x 30   | 02        | 0.8                    | 1.0 + 0.4 | 15.5              | 17.5                 | 16.5 ± 0.2 | 33                | ≈ 11.7   | 200                  |
| 18 x 30   | 03        | 0.8                    | 1.0 + 0.4 | 18.5              | 19.5                 | 18.5 ± 0.2 | 33                | ≈ 12.9   | 240                  |
| 18 x 38   | 04        | 0.8                    | 1.0 + 0.4 | 18.5              | 19.5                 | 18.5 ± 0.2 | 42                | ≈ 19.0   | 100                  |
| 21 x 38   | 05        | 0.8                    | 1.0 + 0.4 | 21.5              | 22.5                 | 21.5 ± 0.2 | 42                | ≈ 24.0   | 100                  |



| ELECTRICAL DATA |   |
|-----------------|---|
| SYMBOL          | DESCRIPTION   |
| $C_R$           | Rated capacitance at 100 Hz, tolerance $\pm 20\%$                                       |
| $I_R$           | Rated RMS ripple current at 100 Hz, 105 °C  |
| $I_{L5}$        | Max. leakage current after 5 min at $U_R$   |
| $\tan \delta$   | Max. dissipation factor at 100 Hz   |
| ESR             | Equivalent series resistance at 100 Hz (calculated from $\tan \delta_{max}$ and $C_R$ ) |
| Z               | Max. impedance at 10 kHz or 100 kHz   |

**ORDERING EXAMPLE**

Electrolytic capacitor 138 series  
 470  $\mu$ F / 10 V;  $\pm 20\%$   
 Nominal case size:  $\varnothing$  8 mm x 18 mm; Form BA  
 Ordering code: MAL213834471E3  
 Former 12 NC: 2222 138 34471

**Note**

- Unless otherwise specified, all electrical values in Table 3 apply at  $T_{amb} = 20\text{ °C}$ ,  $P = 86\text{ kPa}$  to 106 kPa, RH = 45 % to 75 %.

**Table 3**

| ELECTRICAL DATA AND ORDERING INFORMATION |                               |   |                                   |                                 |                         |                               |                             |                              |                            |                             |                            |                             |
|--|-------------------------------|---|-----------------------------------|---------------------------------|-------------------------|-------------------------------|-----------------------------|------------------------------|----------------------------|-----------------------------|----------------------------|-----------------------------|
| $U_R$<br>(V)                             | $C_R$<br>100 Hz<br>( $\mu$ F) | NOMINAL<br>CASE SIZE<br>$\varnothing$ D x L<br>(mm) | $I_R$<br>100 Hz<br>105 °C<br>(mA) | $I_{L5}$<br>5 min<br>( $\mu$ A) | $\tan \delta$<br>100 Hz | ESR<br>100 Hz<br>( $\Omega$ ) | Z<br>10 kHz<br>( $\Omega$ ) | Z<br>100 kHz<br>( $\Omega$ ) | ORDERING CODE MAL2138..... |                             |                            |                             |
|  |                               |   |                                   |                                 |                         |                               |                             |                              | IN BOX<br>FORM AA          | TAPED<br>ON REEL<br>FORM BR | TAPED<br>IN BOX<br>FORM BA | MOUNTING<br>RING<br>FORM MR |
| 6.3                                      | 100                           | 6.3 x 12.7  | 99                                | 5.3                             | 0.24                    | 3.800                         | 3.000                       | 1.800                        | -                          | 23101E3                     | 33101E3                    | -                           |
|  | 220                           | 7.7 x 12.7  | 160                               | 6.8                             | 0.24                    | 1.700                         | 1.400                       | 0.950                        | -                          | 23221E3                     | 33221E3                    | -                           |
|  | 470                           | 6.5 x 18  | 250                               | 9.9                             | 0.24                    | 0.810                         | 0.640                       | 0.500                        | -                          | 23471E3                     | 33471E3                    | -                           |
|  | 1000                          | 10 x 18   | 430                               | 17                              | 0.24                    | 0.380                         | 0.300                       | 0.240                        | -                          | 23102E3                     | 33102E3                    | -                           |
|  | 2200                          | 10 x 25   | 640                               | 32                              | 0.29                    | 0.210                         | 0.180                       | 0.150                        | -                          | 23222E3                     | 33222E3                    | -                           |
| 10                                       | 150                           | 7.7 x 12.7  | 140                               | 7.0                             | 0.2                     | 2.100                         | 1.300                       | 0.950                        | -                          | 24151E3                     | 34151E3                    | -                           |
|  | 220                           | 6.5 x 18  | 190                               | 8.4                             | 0.2                     | 1.400                         | 0.910                       | 0.500                        | -                          | 24221E3                     | 34221E3                    | -                           |
|  | 470                           | 8 x 18  | 300                               | 13                              | 0.2                     | 0.680                         | 0.430                       | 0.350                        | -                          | 24471E3                     | 34471E3                    | -                           |
|  | 1000                          | 10 x 25   | 520                               | 24                              | 0.2                     | 0.320                         | 0.200                       | 0.160                        | -                          | 24102E3                     | 34102E3                    | -                           |
|  | 1500                          | 10 x 30   | 670                               | 34                              | 0.28                    | 0.320                         | 0.260                       | 0.260                        | 14152E3                    | 24152E3                     | -                          | -                           |
|  | 2200                          | 12.5 x 30   | 890                               | 48                              | 0.29                    | 0.220                         | 0.190                       | 0.190                        | 14222E3                    | 24222E3                     | -                          | -                           |
|  | 3300                          | 15 x 30   | 1140                              | 70                              | 0.30                    | 0.160                         | 0.130                       | 0.150                        | 14332E3                    | 24332E3                     | -                          | 44332E3                     |
|  | 4700                          | 18 x 30   | 1450                              | 98                              | 0.33                    | 0.120                         | 0.110                       | 0.130                        | 14472E3                    | -                           | -                          | 44472E3                     |
|  | 6800                          | 18 x 38   | 1880                              | 140                             | 0.34                    | 0.085                         | 0.074                       | 0.110                        | 14682E3                    | -                           | -                          | 44682E3                     |
|  | 10 000                        | 18 x 38   | 1980                              | 200                             | 0.41                    | 0.070                         | 0.062                       | 0.100                        | 14103E3                    | -                           | -                          | 44103E3                     |
| 15 000                                   | 21 x 38                       | 2200  | 300                               | 0.55                            | 0.063                   | 0.058                         | 0.099                       | 14153E3                      | -                          | -                           | 44153E3                    |                             |
| 16                                       | 22                            | 6.3 x 12.7  | 58                                | 4.7                             | 0.12                    | 8.700                         | 7.300                       | 2.700                        | -                          | 25229E3                     | 35229E3                    | -                           |
|  | 47                            | 6.3 x 12.7  | 83                                | 5.5                             | 0.16                    | 5.400                         | 3.400                       | 1.900                        | -                          | 25479E3                     | 35479E3                    | -                           |
|  | 100                           | 7.7 x 12.7  | 130                               | 7.2                             | 0.16                    | 2.500                         | 1.600                       | 1.000                        | -                          | 25101E3                     | 35101E3                    | -                           |
|  | 220                           | 8 x 18  | 230                               | 11                              | 0.16                    | 1.200                         | 0.730                       | 0.350                        | -                          | 25221E3                     | 35221E3                    | -                           |
|  | 470                           | 10 x 18   | 360                               | 19                              | 0.16                    | 0.540                         | 0.340                       | 0.250                        | -                          | 25471E3                     | 35471E3                    | -                           |
|  | 1000                          | 10 x 30   | 630                               | 36                              | 0.20                    | 0.340                         | 0.270                       | 0.260                        | 15102E3                    | 25102E3                     | -                          | -                           |
|  | 1500                          | 12.5 x 30   | 860                               | 52                              | 0.20                    | 0.230                         | 0.190                       | 0.190                        | 15152E3                    | 25152E3                     | -                          | -                           |
|  | 2200                          | 15 x 30   | 1090                              | 74                              | 0.21                    | 0.170                         | 0.140                       | 0.150                        | 15222E3                    | 25222E3                     | -                          | 45222E3                     |
|  | 3300                          | 18 x 30   | 1420                              | 110                             | 0.24                    | 0.120                         | 0.100                       | 0.130                        | 15332E3                    | -                           | -                          | 45332E3                     |
|  | 4700                          | 18 x 30   | 1480                              | 150                             | 0.28                    | 0.100                         | 0.090                       | 0.120                        | 15472E3                    | -                           | -                          | 45472E3                     |
| 6800                                     | 18 x 38                       | 1930  | 220                               | 0.28                            | 0.072                   | 0.062                         | 0.100                       | 15682E3                      | -                          | -                           | 45682E3                    |                             |
| 10 000                                   | 21 x 38                       | 2100  | 320                               | 0.38                            | 0.065                   | 0.057                         | 0.098                       | 15103E3                      | -                          | -                           | 45103E3                    |                             |
| 25                                       | 10                            | 6.3 x 12.7  | 46                                | 4.5                             | 0.09                    | 14.000                        | 12.000                      | 2.800                        | -                          | 26109E3                     | 36109E3                    | -                           |
|  | 22                            | 6.3 x 12.7  | 61                                | 5.1                             | 0.14                    | 10.000                        | 5.500                       | 2.500                        | -                          | 26229E3                     | 36229E3                    | -                           |
|  | 47                            | 7.7 x 12.7  | 96                                | 6.4                             | 0.14                    | 4.700                         | 2.600                       | 1.000                        | -                          | 26479E3                     | 36479E3                    | -                           |



| ELECTRICAL DATA AND ORDERING INFORMATION |                            |                                |                                   |                            |              |                |              |               |                            |                       |                      |                       |
|--|----------------------------|--------------------------------|-----------------------------------|----------------------------|--------------|----------------|--------------|---------------|----------------------------|-----------------------|----------------------|-----------------------|
| U <sub>R</sub> (V)                       | C <sub>R</sub> 100 Hz (μF) | NOMINAL CASE SIZE Ø D x L (mm) | I <sub>R</sub> 100 Hz 105 °C (mA) | I <sub>L5</sub> 5 min (μA) | tan δ 100 Hz | ESR 100 Hz (Ω) | Z 10 kHz (Ω) | Z 100 kHz (Ω) | ORDERING CODE MAL2138..... |                       |                      |                       |
|  |                            |                                |                                   |                            |              |                |              |               | IN BOX FORM AA             | TAPED ON REEL FORM BR | TAPED IN BOX FORM BA | MOUNTING RING FORM MR |
| 25                                       | 100                        | 6.5 x 18                       | 160                               | 9.0                        | 0.13         | 2.100          | 1.200        | 0.550         | -                          | 26101E3               | 36101E3              | -                     |
|  | 220                        | 10 x 18                        | 270                               | 15                         | 0.13         | 0.940          | 0.550        | 0.270         | -                          | 26221E3               | 36221E3              | -                     |
|  | 470                        | 10 x 25                        | 440                               | 28                         | 0.13         | 0.440          | 0.260        | 0.170         | -                          | 26471E3               | 36471E3              | -                     |
|  | 680                        | 10 x 30                        | 580                               | 38                         | 0.14         | 0.360          | 0.260        | 0.250         | 16681E3                    | 26681E3               | -                    | -                     |
|  | 1000                       | 12.5 x 30                      | 790                               | 54                         | 0.15         | 0.250          | 0.180        | 0.190         | 16102E3                    | 26102E3               | -                    | -                     |
|  | 1500                       | 15 x 30                        | 1020                              | 79                         | 0.15         | 0.170          | 0.130        | 0.150         | 16152E3                    | 26152E3               | -                    | 46152E3               |
|  | 2200                       | 18 x 30                        | 1320                              | 110                        | 0.17         | 0.130          | 0.100        | 0.130         | 16222E3                    | -                     | -                    | 46222E3               |
|  | 3300                       | 18 x 38                        | 1720                              | 170                        | 0.17         | 0.090          | 0.071        | 0.110         | 16332E3                    | -                     | -                    | 46332E3               |
|  | 4700                       | 18 x 38                        | 1840                              | 240                        | 0.21         | 0.076          | 0.063        | 0.100         | 16472E3                    | -                     | -                    | 46472E3               |
| 6800                                     | 21 x 38                    | 2100                           | 340                               | 0.27                       | 0.068        | 0.058          | 0.099        | 16682E3       | -                          | -                     | 46682E3              |                       |
| 40                                       | 33                         | 7.7 x 12.7                     | 91                                | 6.6                        | 0.11         | 5.300          | 2.700        | 1.000         | -                          | 27339E3               | 37339E3              | -                     |
|  | 47                         | 6.5 x 18                       | 120                               | 7.8                        | 0.10         | 3.400          | 1.900        | 0.650         | -                          | 27479E3               | 37479E3              | -                     |
|  | 100                        | 8 x 18                         | 180                               | 12                         | 0.10         | 1.600          | 0.900        | 0.400         | -                          | 27101E3               | 37101E3              | -                     |
|  | 220                        | 10 x 25                        | 350                               | 22                         | 0.10         | 0.720          | 0.410        | 0.200         | -                          | 27221E3               | 37221E3              | -                     |
|  | 330                        | 10 x 30                        | 490                               | 30                         | 0.10         | 0.470          | 0.320        | 0.300         | 17331E3                    | 27331E3               | -                    | -                     |
|  | 470                        | 12.5 x 30                      | 650                               | 42                         | 0.10         | 0.340          | 0.230        | 0.220         | 17471E3                    | 27471E3               | -                    | -                     |
|  | 680                        | 12.5 x 30                      | 750                               | 58                         | 0.10         | 0.250          | 0.180        | 0.180         | 17681E3                    | 27681E3               | -                    | -                     |
|  | 1000                       | 15 x 30                        | 970                               | 84                         | 0.10         | 0.170          | 0.120        | 0.140         | 17102E3                    | 27102E3               | -                    | 47102E3               |
|  | 1500                       | 18 x 30                        | 1250                              | 120                        | 0.12         | 0.130          | 0.098        | 0.120         | 17152E3                    | -                     | -                    | 47152E3               |
| 2200                                     | 18 x 38                    | 1640                           | 180                               | 0.12                       | 0.093        | 0.069          | 0.100        | 17222E3       | -                          | -                     | 47222E3              |                       |
| 3300                                     | 21 x 38                    | 1810                           | 270                               | 0.15                       | 0.079        | 0.061          | 0.100        | 17332E3       | -                          | -                     | 47332E3              |                       |
| 50                                       | 10                         | 6.3 x 12.7                     | 51                                | 5.0                        | 0.09         | 14.00          | 7.000        | 2.700         | -                          | 21109E3               | 31109E3              | -                     |
|  | 22                         | 7.7 x 12.7                     | 82                                | 6.2                        | 0.09         | 6.500          | 3.200        | 1.100         | -                          | 21229E3               | 31229E3              | -                     |
|  | 100                        | 10 x 18                        | 230                               | 14                         | 0.08         | 1.300          | 0.700        | 0.300         | -                          | 21101E3               | 31101E3              | -                     |
| 63                                       | 4.7                        | 6.3 x 12.7                     | 35                                | 4.6                        | 0.09         | 30.00          | 17.000       | 5.000         | -                          | 28478E3               | 38478E3              | -                     |
|  | 10                         | 7.7 x 12.7                     | 59                                | 5.3                        | 0.08         | 13.00          | 8.000        | 1.800         | -                          | 28109E3               | 38109E3              | -                     |
|  | 22                         | 6.5 x 18                       | 100                               | 6.8                        | 0.07         | 5.100          | 3.600        | 0.850         | -                          | 28229E3               | 38229E3              | -                     |
|  | 47                         | 8 x 18                         | 150                               | 9.9                        | 0.07         | 2.400          | 1.700        | 0.500         | -                          | 28479E3               | 38479E3              | -                     |
|  | 100                        | 10 x 25                        | 280                               | 17                         | 0.07         | 1.100          | 0.800        | 0.270         | -                          | 28101E3               | 38101E3              | -                     |
|  | 150                        | 10 x 30                        | 410                               | 23                         | 0.11         | 0.730          | 0.440        | 0.400         | 18151E3                    | 28151E3               | -                    | -                     |
|  | 220                        | 12.5 x 30                      | 560                               | 32                         | 0.11         | 0.500          | 0.310        | 0.290         | 18221E3                    | 28221E3               | -                    | -                     |
|  | 330                        | 12.5 x 30                      | 660                               | 46                         | 0.12         | 0.370          | 0.230        | 0.220         | 18331E3                    | 28331E3               | -                    | -                     |
|  | 470                        | 15 x 30                        | 860                               | 63                         | 0.12         | 0.260          | 0.160        | 0.160         | 18471E3                    | 28471E3               | -                    | 48471E3               |
|  | 680                        | 18 x 30                        | 1130                              | 90                         | 0.12         | 0.190          | 0.120        | 0.140         | 18681E3                    | -                     | -                    | 48681E3               |
| 1000                                     | 18 x 38                    | 1460                           | 130                               | 0.12                       | 0.130        | 0.086          | 0.110        | 18102E3       | -                          | -                     | 48102E3              |                       |
| 1500                                     | 21 x 38                    | 1680                           | 190                               | 0.13                       | 0.100        | 0.072          | 0.110        | 18152E3       | -                          | -                     | 48152E3              |                       |
| 100                                      | 2.2                        | 6.3 x 12.7                     | 24                                | 4.4                        | 0.09         | 65.00          | 25.000       | 8.000         | -                          | 29228E3               | 39228E3              | -                     |
|  | 4.7                        | 7.7 x 12.7                     | 40                                | 4.9                        | 0.08         | 27.00          | 17.000       | 5.000         | -                          | 29478E3               | 39478E3              | -                     |
|  | 10                         | 6.5 x 18                       | 67                                | 6.0                        | 0.07         | 11.00          | 8.000        | 2.400         | -                          | 29109E3               | 39109E3              | -                     |
|  | 22                         | 8 x 18                         | 100                               | 8.4                        | 0.07         | 5.100          | 3.600        | 1.400         | -                          | 29229E3               | 39229E3              | -                     |
|  | 47                         | 10 x 25                        | 190                               | 13                         | 0.07         | 2.400          | 1.700        | 0.670         | -                          | 29479E3               | 39479E3              | -                     |
|  | 68                         | 10 x 30                        | 300                               | 18                         | 0.07         | 1.700          | 1.100        | 0.970         | 19689E3                    | 29689E3               | -                    | -                     |
|  | 100                        | 12.5 x 30                      | 410                               | 24                         | 0.07         | 1.100          | 0.770        | 0.670         | 19101E3                    | 29101E3               | -                    | -                     |
|  | 150                        | 15 x 30                        | 550                               | 34                         | 0.07         | 0.780          | 0.520        | 0.460         | 19151E3                    | 29151E3               | -                    | 49151E3               |
|  | 220                        | 15 x 30                        | 650                               | 48                         | 0.07         | 0.540          | 0.370        | 0.330         | 19221E3                    | 29221E3               | -                    | 49221E3               |
|  | 330                        | 18 x 30                        | 880                               | 70                         | 0.08         | 0.380          | 0.270        | 0.240         | 19331E3                    | -                     | -                    | 49331E3               |
|  | 470                        | 18 x 38                        | 1130                              | 98                         | 0.08         | 0.270          | 0.190        | 0.170         | 19471E3                    | -                     | -                    | 49471E3               |
| 680                                      | 21 x 38                    | 1330                           | 140                               | 0.09                       | 0.210        | 0.140          | 0.140        | 19681E3       | -                          | -                     | 49681E3              |                       |

| ADDITIONAL ELECTRICAL DATA         |   |  |               |
|------------------------------------|---|--|---------------|
| PARAMETER                          | CONDITIONS  | VALUE  |               |
|                                    |   | AXIAL  | MOUNTING RING |
| <b>Voltage</b>                     |   |  |               |
| Surge voltage                      |   | $U_s \leq 1.15 \times U_R$                         |               |
| Reverse voltage                    |   | $U_{rev} \leq 1 \text{ V}$                         |               |
| <b>Current</b>                     |   |  |               |
| Leakage current                    | After 1 min at $U_R$ :  |  |               |
|                                    | case $\varnothing D \times L = 6.3 \text{ mm} \times 12.7 \text{ mm}$ and $7.7 \text{ mm} \times 12.7 \text{ mm}$ | $I_{L1} \leq 0.02 C_R \times U_R + 3 \mu\text{A}$  |               |
|                                    | case $\varnothing D \times L = 6.5 \text{ mm} \times 18 \text{ mm}$ to $21 \text{ mm} \times 38 \text{ mm}$       | $I_{L1} \leq 0.006 C_R \times U_R + 4 \mu\text{A}$ |               |
|                                    | After 5 min at $U_R$  | $I_{L5} \leq 0.002 C_R \times U_R + 4 \mu\text{A}$ |               |
| <b>Inductance</b>                  |   |  |               |
| Equivalent series inductance (ESL) | Case $\varnothing D \times L$ mm:   |  |               |
|                                    | 6.3 x 12.7  | Typ. 20 nH   | -             |
|                                    | 7.7 x 12.7  | Typ. 30 nH   | -             |
|                                    | 6.5 x 18  | Typ. 15 nH   | -             |
|                                    | 8 x 18  | Typ. 35 nH   | -             |
|                                    | 10 x 18   | Typ. 69 nH   | -             |
|                                    | 10 x 25   | Typ. 38 nH   | -             |
|                                    | 10 x 30   | Typ. 38 nH   | -             |
|                                    | 12.5 x 30   | Typ. 46 nH   | -             |
|                                    | 15 x 30   | Typ. 48 nH   | Typ. 39 nH    |
|                                    | 18 x 30   | Typ. 50 nH   | Typ. 39 nH    |
|                                    | 18 x 38   | Typ. 54 nH   | Typ. 39 nH    |
| 21 x 38                            | Typ. 59 nH  | Typ. 39 nH   |               |

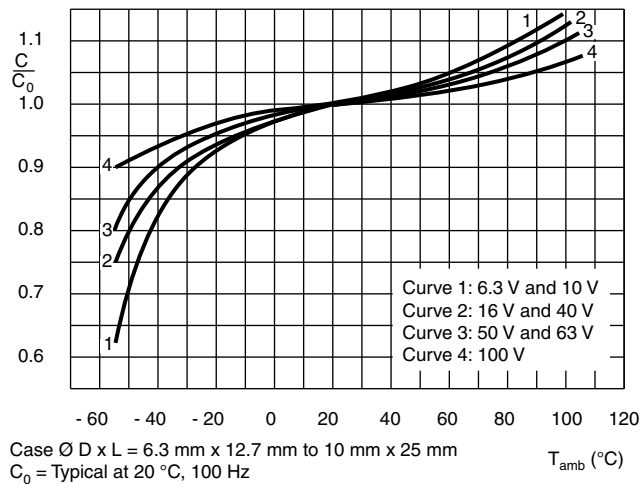
**CAPACITANCE (C)**


Fig. 6 - Typical multiplier of capacitance as a function of ambient temperature

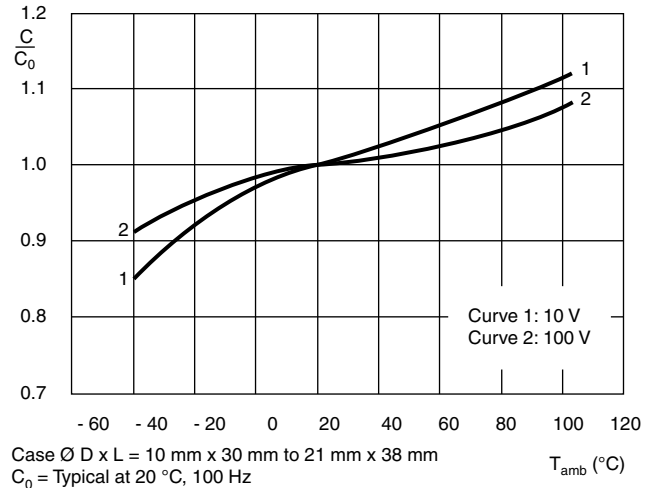


Fig. 7 - Typical multiplier of capacitance as a function of ambient temperature

**EQUIVALENT SERIES RESISTANCE (ESR)**

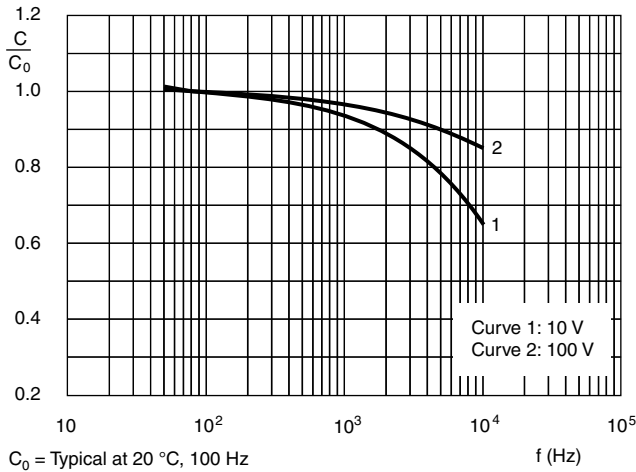


Fig. 8 - Typical multiplier of capacitance as a function of frequency

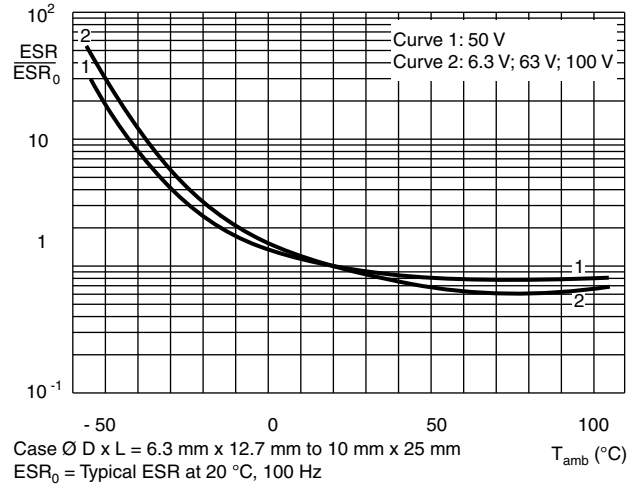


Fig. 9 - Typical multiplier of ESR as a function of ambient temperature

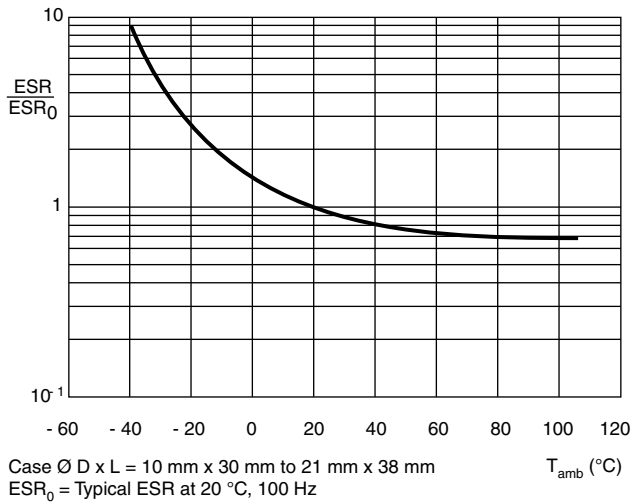


Fig. 10 - Typical multiplier of ESR as a function of ambient temperature

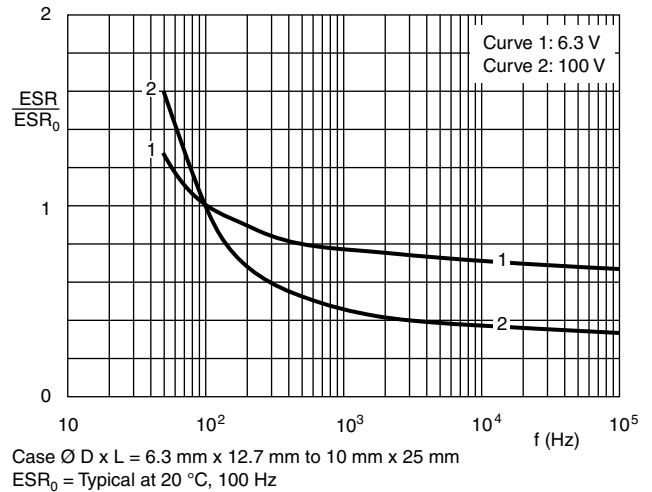


Fig. 11 - Typical multiplier ESR as a function of frequency

**EQUIVALENT SERIES RESISTANCE (ESR)**

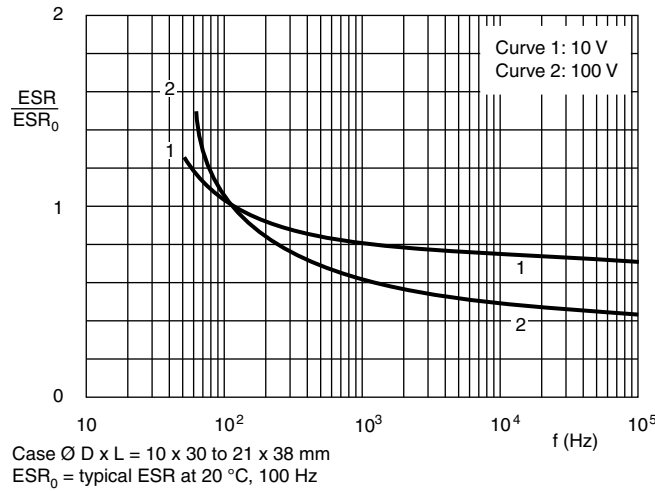


Fig. 12 - Typical multiplier ESR as a function of frequency

**IMPEDANCE (Z)**

Table 4

| IMPEDANCE VS. CAPACITANCE VALUES (Case $\varnothing$ D x L = 6.3 mm x 12.7 mm to 10 mm x 25 mm) |  |        |        |        |        |       |        |        |
|---|--|--------|--------|--------|--------|-------|--------|--------|
| $T_{amb}$   | $Z \times C_R (\Omega \times \mu F)$ AT 10 kHz |        |        |        |        |       |        |        |
|   | 6.3 V  | 10 V   | 16 V   | 25 V   | 40 V   | 50 V  | 63 V   | 100 V  |
| +20 °C  | ≤ 300  | ≤ 200  | ≤ 160  | ≤ 120  | ≤ 90   | ≤ 70  | ≤ 80   | ≤ 80   |
| -25 °C  | ≤ 2000   | ≤ 1200 | ≤ 750  | ≤ 560  | ≤ 450  | ≤ 300 | ≤ 550  | ≤ 550  |
| -40 °C  | ≤ 5500   | ≤ 3200 | ≤ 2000 | ≤ 1500 | ≤ 1200 | ≤ 900 | ≤ 1500 | ≤ 1500 |

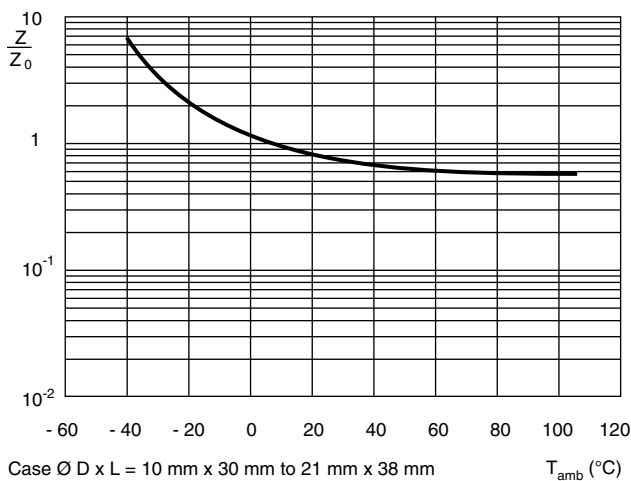


Fig. 13 - Typical multiplier of ESR as a function of ambient temperature at 10 kHz

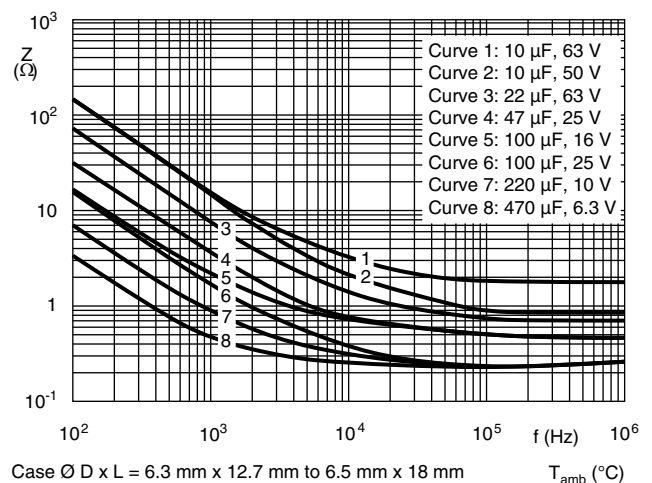


Fig. 14 - Typical impedance as a function of frequency



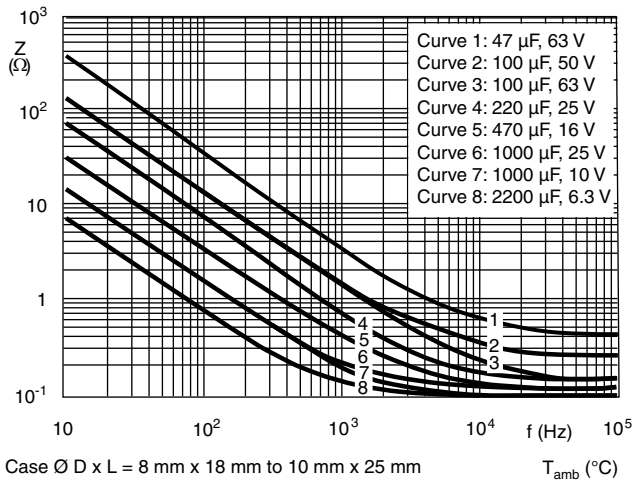


Fig. 15 - Typical impedance as a function of frequency

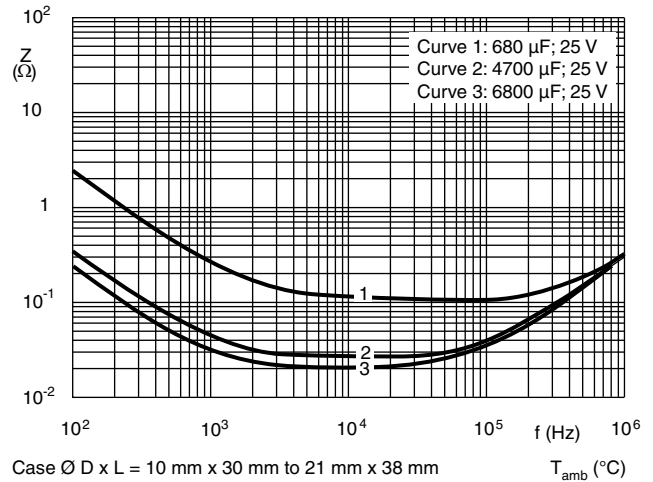


Fig. 16 - Typical impedance as a function of frequency

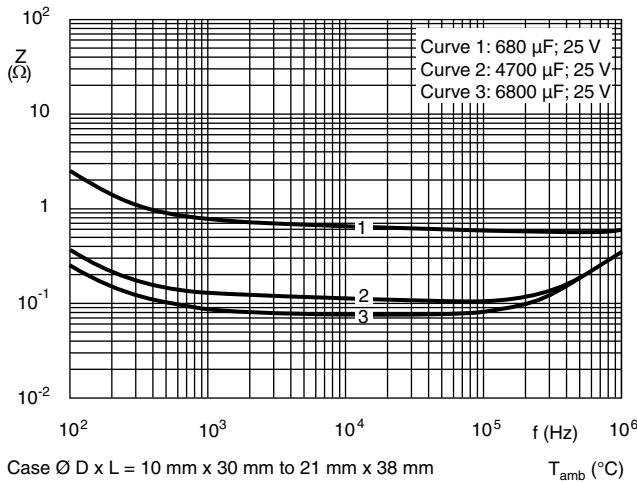


Fig. 17 - Typical impedance as a function of frequency

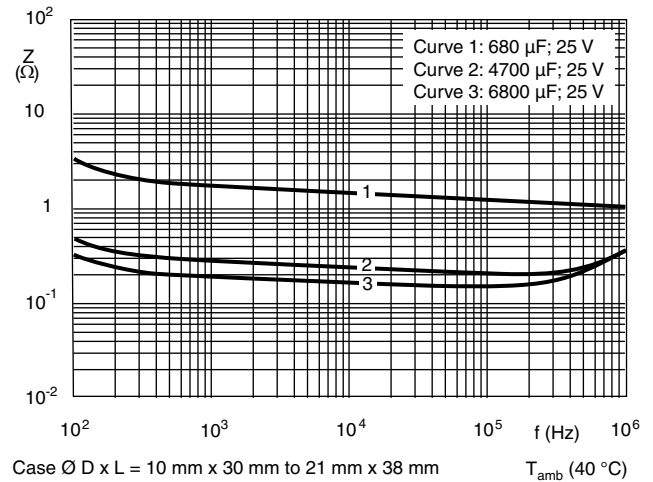


Fig. 18 - Typical impedance as a function of frequency

**RIPPLE CURRENT AND USEFUL LIFE**

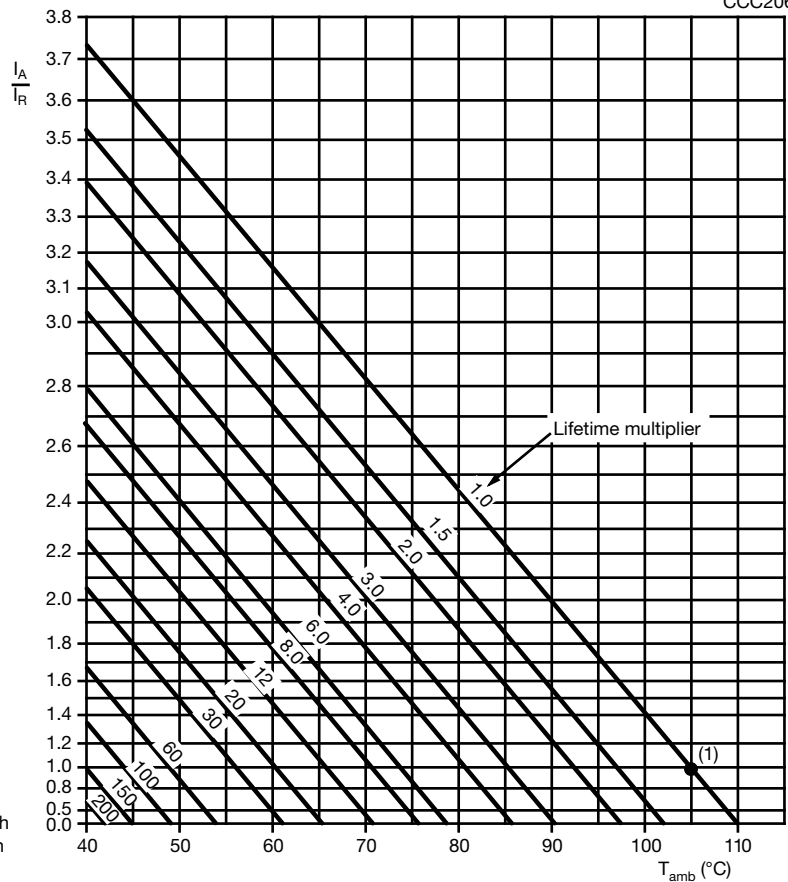
Table 5

| ENDURANCE TEST DURATION AND USEFUL LIFE |                               |                                 |
|---|-------------------------------|---------------------------------|
| NOMINAL CASE SIZE<br>Ø D x L<br>(mm)    | ENDURANCE<br>AT 105 °C<br>(h) | USEFUL LIFE<br>AT 105 °C<br>(h) |
| 6.5 x 18                                | 1000                          | 2000                            |
| 8 x 18                                  | 1000                          | 2000                            |
| 10 x 18                                 | 1000                          | 2000                            |
| 10 x 25                                 | 1000                          | 2000                            |
| 10 x 30                                 | 5000                          | 10 000                          |
| 12.5 x 30                               | 5000                          | 10 000                          |
| 15 x 30                                 | 5000                          | 10 000                          |
| 18 x 30                                 | 5000                          | 10 000                          |
| 18 x 38                                 | 5000                          | 10 000                          |
| 21 x 38                                 | 5000                          | 10 000                          |

**Note**

- Multiplier of useful life code: CCC206

CCC206



$I_A$  = Actual ripple current at 100 Hz  
 $I_R$  = Rated ripple current at 100 Hz, 105 °C

(1) Useful life at 105 °C and  $I_R$  applied:  
 Case Ø D x L = 6.3 mm x 12.7 mm to 10 mm x 25 mm: 2000 h  
 Case Ø D x L = 10 mm x 30 mm to 21 mm x 38 mm: 10 000 h

Fig. 19 - Multiplier of useful life as a function of ambient temperature and ripple current load

Table 6

| <b>MULTIPLIER OF RIPPLE CURRENT (<math>I_R</math>) AS A FUNCTION OF FREQUENCY</b> |                |      |      |      |      |                |
|---|----------------|------|------|------|------|----------------|
| $U_R$<br>(V)  | FREQUENCY (Hz) |      |      |      |      |                |
|   | 50             | 100  | 300  | 1000 | 3000 | $\geq 10\ 000$ |
| $I_R$ MULTIPLIER  |                |      |      |      |      |                |
| 6.3   | 0.95           | 1.00 | 1.07 | 1.12 | 1.15 | 1.20           |
| 10  | 0.95           | 1.00 | 1.07 | 1.12 | 1.15 | 1.20           |
| 16  | 0.90           | 1.00 | 1.12 | 1.20 | 1.25 | 1.30           |
| 25  | 0.90           | 1.00 | 1.12 | 1.20 | 1.25 | 1.30           |
| 40  | 0.85           | 1.00 | 1.20 | 1.30 | 1.35 | 1.40           |
| 50  | 0.85           | 1.00 | 1.20 | 1.30 | 1.35 | 1.40           |
| 63  | 0.85           | 1.00 | 1.20 | 1.30 | 1.35 | 1.40           |
| 100   | 0.85           | 1.00 | 1.20 | 1.30 | 1.35 | 1.40           |

Table 7

| <b>TEST PROCEDURES AND REQUIREMENTS</b>        |  |   |   |
|--|--|---|---|
| TEST   |  | PROCEDURE<br>(quick reference)  | REQUIREMENTS  |
| NAME OF TEST                                   | REFERENCE                                    |   |   |
| Endurance                                      | IEC 60384-4 /<br>EN130300<br>subclause 4.13  | $T_{amb} = 105\ ^\circ\text{C}$ ; $U_R$ applied;<br>Case $\varnothing D \times L$ :<br>6.3 mm x 12.7 mm to 10 mm x 25 mm: 1000 h;<br>10 mm x 30 mm to 21 mm x 38 mm: 5000 h             | $U_R \leq 6.3\ \text{V}$ ; $\Delta C/C$ : +15 % / -30 %<br>$U_R > 6.3\ \text{V}$ ; $\Delta C/C$ : $\pm 15\ \%$<br>$\tan \delta \leq 1.3 \times \text{spec. limit}$<br>$Z \leq 2 \times \text{spec. limit}$<br>$I_{L5} \leq \text{spec. limit}$  |
| Useful life                                    | CECC 30301<br>subclause 1.8.1                | $T_{amb} = 105\ ^\circ\text{C}$ ; $U_R$ and $I_R$ applied;<br>Case $\varnothing D \times L$ :<br>6.3 mm x 12.7 mm to 10 mm x 25 mm: 2000 h;<br>10 mm x 30 mm to 21 mm x 38 mm: 10 000 h | $U_R \leq 6.3\ \text{V}$ ; $\Delta C/C$ : +45 % / -50 %<br>$U_R > 6.3\ \text{V}$ ; $\Delta C/C$ : $\pm 45\ \%$<br>$\tan \delta \leq 3 \times \text{spec. limit}$<br>$Z \leq 3 \times \text{spec. limit}$<br>$I_{L5} \leq \text{spec. limit}$<br>no short open circuit<br>total failure percentage: $\leq 1\ \%$ |
| Shelf life<br>(storage at<br>high temperature) | IEC 60384-4 /<br>EN130300,<br>subclause 4.17 | $T_{amb} = 105\ ^\circ\text{C}$ ; no voltage applied;<br>500 h<br>After test: $U_R$ to be applied for 30 min,<br>24 h to 48 h before measurement  | $\Delta C/C$ , $\tan \delta$ , $Z$ :<br>for requirements<br>see "Endurance test" above<br>$I_{L5} \leq 2 \times \text{spec. limit}$   |

Statements about product lifetime are based on calculations and internal testing. They should only be interpreted as estimations. Also due to external factors, the lifetime in the field application may deviate from the calculated lifetime. In general, nothing stated herein shall be construed as a guarantee of durability.



## **Disclaimer**

ALL PRODUCT, PRODUCT SPECIFICATIONS AND DATA ARE SUBJECT TO CHANGE WITHOUT NOTICE TO IMPROVE RELIABILITY, FUNCTION OR DESIGN OR OTHERWISE.

Vishay Intertechnology, Inc., its affiliates, agents, and employees, and all persons acting on its or their behalf (collectively, "Vishay"), disclaim any and all liability for any errors, inaccuracies or incompleteness contained in any datasheet or in any other disclosure relating to any product.

Vishay makes no warranty, representation or guarantee regarding the suitability of the products for any particular purpose or the continuing production of any product. To the maximum extent permitted by applicable law, Vishay disclaims (i) any and all liability arising out of the application or use of any product, (ii) any and all liability, including without limitation special, consequential or incidental damages, and (iii) any and all implied warranties, including warranties of fitness for particular purpose, non-infringement and merchantability.

Statements regarding the suitability of products for certain types of applications are based on Vishay's knowledge of typical requirements that are often placed on Vishay products in generic applications. Such statements are not binding statements about the suitability of products for a particular application. It is the customer's responsibility to validate that a particular product with the properties described in the product specification is suitable for use in a particular application. Parameters provided in datasheets and / or specifications may vary in different applications and performance may vary over time. All operating parameters, including typical parameters, must be validated for each customer application by the customer's technical experts. Product specifications do not expand or otherwise modify Vishay's terms and conditions of purchase, including but not limited to the warranty expressed therein.

Except as expressly indicated in writing, Vishay products are not designed for use in medical, life-saving, or life-sustaining applications or for any other application in which the failure of the Vishay product could result in personal injury or death. Customers using or selling Vishay products not expressly indicated for use in such applications do so at their own risk. Please contact authorized Vishay personnel to obtain written terms and conditions regarding products designed for such applications.

No license, express or implied, by estoppel or otherwise, to any intellectual property rights is granted by this document or by any conduct of Vishay. Product names and markings noted herein may be trademarks of their respective owners.