

WIDEBAND, FET-INPUT OPERATIONAL AMPLIFIER

FEATURES

- **Gain Bandwidth Product: 180 MHz**
- **Slew Rate: 100 V/ μ s**
- **Maximum Input Bias Current: 100 pA**
- **Input Voltage Noise: 5.4 nV/ $\sqrt{\text{Hz}}$**
- **Maximum Input Offset Voltage: 4 mV**
- **Input Impedance: $10^9 \Omega \parallel 10 \text{ pF}$**
- **Power Supply Voltage Range: ± 5 to $\pm 15 \text{ V}$**
- **Unity Gain Stable**

APPLICATIONS

- **Wideband Photodiode Amplifier**
- **High-Speed Transimpedance Gain Stage**
- **Test and Measurement Systems**
- **Current-DAC Output Buffer**
- **Active Filtering**
- **High-Speed Signal Integrator**
- **High-Impedance Buffer**

DESCRIPTION

The THS4601 is a high-speed, FET-input operational amplifier designed for applications requiring wideband operation, high-input impedance, and high-power supply voltages. By providing a 180-MHz gain-bandwidth product, $\pm 15\text{-V}$ supply operation, and 100-pA input bias current, the THS4601 is capable of wideband transimpedance gain and large output signal swing simultaneously. Low current and voltage noise allow amplification of extremely low-level input signals while still maintaining a large signal-to-noise ratio.

The characteristics of the THS4601 ideally suit it for use as a wideband photodiode amplifier. Photodiode output current is a prime candidate for transimpedance amplification, an application of which is illustrated in Figure 1. Other potential applications include test and measurement systems requiring high-input impedance, digital-to-analog converter output buffering, high-speed integration, and active filtering.

A SELECTION OF RELATED OPERATIONAL AMPLIFIER PRODUCTS

DEVICE	V _S (V)	BW (MHz)	SLEW RATE (V/ μ s)	VOLTAGE NOISE (nV/ $\sqrt{\text{Hz}}$)	DESCRIPTION
OPA627	± 15	16	55	4.5	Unity-gain stable FET-input amplifier
OPA637	± 15	80	135	4.5	Gain of +5 stable FET-input amplifier
OPA655	± 5	400	290	6	Unity-gain stable FET-input amplifier

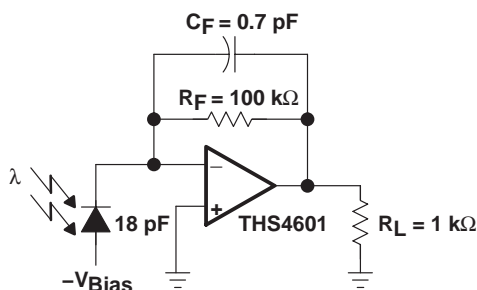
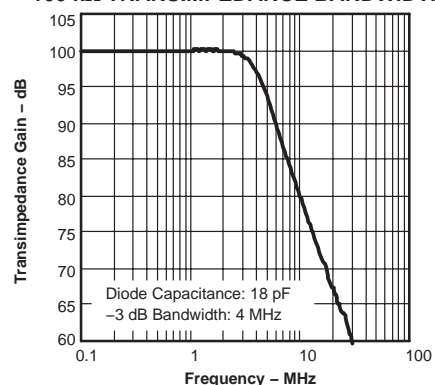

Figure 1. Wideband Photodiode Transimpedance Amplifier

100 k Ω TRANSIMPEDANCE BANDWIDTH



Please be aware that an important notice concerning availability, standard warranty, and use in critical applications of Texas Instruments semiconductor products and disclaimers thereto appears at the end of this data sheet.

PRODUCTION DATA information is current as of publication date. Products conform to specifications per the terms of Texas Instruments standard warranty. Production processing does not necessarily include testing of all parameters.

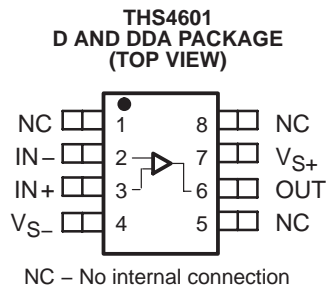

Terminal Functions

TERMINAL NAME	NO.	DESCRIPTION
NC	1, 5, 8	These pins have no internal connection.
IN-	2	Inverting input of the amplifier
IN+	3	Noninverting input of the amplifier
VS-	4	Negative power supply
OUT	6	Output of the amplifier
VS+	7	Positive power supply

absolute maximum ratings over operating free-air temperature (unless otherwise noted)†

Supply voltage, V_{S+}	16.5 V
Supply voltage, V_{S-}	-16.5 V
Input voltage, V_I	$\pm V_S$
Output current, I_O	100 mA
Differential input voltage, V_{ID}	± 4 V
Maximum junction temperature, T_J	150°C
Operating free-air temperature, T_A : C-suffix	0°C to 70°C
I-suffix	-40°C to 85°C
Storage temperature, T_{stg}	-65°C to 125°C
Lead temperature 1,6 mm (1/16 inch) from cases for 10 seconds	300°C

† Stresses beyond those listed under “absolute maximum ratings” may cause permanent damage to the device. These are stress ratings only, and functional operation of the device at these or any other conditions beyond those indicated under “recommended operating conditions” is not implied. Exposure to absolute-maximum-rated conditions for extended periods may affect device reliability.

PACKAGE AND ORDERING INFORMATION

PRODUCT	PACKAGE	PACKAGE DESIGNATOR	SPECIFIED TEMPERATURE RANGE	PACKAGE MARKING
THS4601CD	SOIC surface mount	8D	0°C to 70°C	4601C
THS4601ID	SOIC surface mount	8D	-40°C to 85°C	4601I
THS4601CDDA	SOIC surface mount with PowerPAD™	8DDA	0°C to 70°C	4601C
THS4601IDDA	SOIC surface mount with PowerPAD™	8DDA	-40°C to 85°C	4601I

NOTE: The THS4601 is available taped and reeled. Add an R suffix to the device type when ordering (e.g., THS4601IDR).

electrical specifications: $V_S = \pm 15\text{ V}$; $R_F = 250\ \Omega$, $R_L = 1\ \text{k}\Omega$ and $G = +2$ (unless otherwise noted)

PARAMETER	TEST CONDITIONS	THS4601					UNIT
		TYP	OVER TEMPERATURE				
		25°C	25°C	0°C to 70°C	-40°C to 85°C	MIN/MAX	
AC PERFORMANCE							
Small-signal bandwidth	$G = +1, V_O = 20\ \text{mV}_{pp}, R_F = 0\ \Omega$	440				Typ	MHz
	$G = +2, V_O = 40\ \text{mV}_{pp}, R_F = 62\ \Omega$	95				Typ	MHz
	$G = +5, V_O = 100\ \text{mV}_{pp}, R_F = 500\ \Omega$	36				Typ	MHz
	$G = +10, V_O = 200\ \text{mV}_{pp}, R_F = 1\ \text{k}\Omega$	18				Typ	MHz
Gain-bandwidth product	$G > +10$	180				Typ	MHz
Bandwidth for 0.1 dB flatness	$G = +2, V_O = 200\ \text{mV}_{pp}$	5				Typ	MHz
Large-signal bandwidth	$G = +5, V_O = 10\ \text{V}_{pp}$	3				Typ	MHz
Slew rate, SR	$G = +5, 10\ \text{V Step}$	100				Typ	V/ μs
Rise/fall time, t_r/t_f	1.0 V Step	7				Typ	ns
Settling time, t_s	0.01%	$G = +5, V_O = 5\ \text{V Step}$	170			Typ	ns
	0.1%	$G = +5, V_O = 5\ \text{V Step}$	135			Typ	ns
Harmonic distortion	$G = +2, f = 1\ \text{MHz}, V_O = 2\ \text{V}_{pp}$						
2 nd Harmonic	$R_L = 100\ \Omega$	-65				Typ	dBc
	$R_L = 1\ \text{k}\Omega$	-77				Typ	
3 rd Harmonic	$R_L = 100\ \Omega$	-73				Typ	dBc
	$R_L = 1\ \text{k}\Omega$	-96				Typ	
Input voltage noise, V_n	$f > 10\ \text{kHz}$	5.4				Typ	nV/ $\sqrt{\text{Hz}}$
Input current noise, I_n	$f > 10\ \text{kHz}$	5.5				Typ	fA/ $\sqrt{\text{Hz}}$
Differential gain (NTSC, PAL)	$G = +2, R_L = 150\ \Omega$	0.02%				Typ	
Differential phase (NTSC, PAL)	$G = +2, R_L = 150\ \Omega$	0.08				Typ	°
DC PERFORMANCE							
Open-loop voltage gain	$G = -10, R_L = 1\ \text{k}\Omega$	105	94	92	90	Min	dB
Input offset voltage, V_{IO}	$V_{CM} = 0\ \text{V}$	1.0	4.0	4.5	5.0	Max	mV
Average offset voltage drift	$V_{CM} = 0\ \text{V}$			± 10	± 10	Typ	$\mu\text{V}/^\circ\text{C}$
Input bias current, I_{IB}	$V_{CM} = 0\ \text{V}$	30	100	550	1100	Max	pA
Average bias current drift	$V_{CM} = 0\ \text{V}$			50	50	Typ	pA/ $^\circ\text{C}$
Input offset current, I_{IO}	$V_{CM} = 0\ \text{V}$	2	100	200	300	Max	pA
Average offset current drift	$V_{CM} = 0\ \text{V}$			5	5	Typ	pA/ $^\circ\text{C}$
INPUT							
Common-mode input range, V_{IC}		± 13.0	12.6 to -12.0	12.5 to -11.9	12.4 to -11.8	Min	V
Common-mode rejection ratio, CMRR		110	100	95	90	Min	dB
Input impedance, Z_{id}	Differential	$10^9 \parallel 3.5$				Typ	$\Omega \parallel \text{pF}$
Input impedance, Z_{ic}	Common-mode	$10^9 \parallel 6.5$				Typ	$\Omega \parallel \text{pF}$

THS4601

SLOS388B – OCTOBER 2001 – REVISED JUNE 2002

electrical specifications: $V_S = \pm 15\text{ V}$; $R_F = 250\ \Omega$, $R_L = 1\text{ k}\Omega$ and $G = +2$ (unless otherwise noted)
(continued)

PARAMETER	TEST CONDITIONS	THS4601					UNIT
		TYP	OVER TEMPERATURE				
		25°C	25°C	0°C to 70°C	-40°C to 85°C	MIN/MAX	
OUTPUT							
Voltage output swing	$R_L = 1\text{ k}\Omega$	12.8 to -13.4	12.4 to -13.1	12.3 to -13.0	12.1 to -12.8	Min	V
Current output, I_O	Sourcing	-80	-60	-60	-59	Min	mA
	Sinking	50	35	35	34	Min	
Closed-loop output impedance, Z_O	$G = +1$, $f = 1\text{ MHz}$	0.1				Typ	Ω
POWER SUPPLY							
Specified operating voltage		± 15	± 16.5	± 16.5	± 16.5	Max	V
Maximum quiescent current		10.0	11.5	11.7	12.0	Max	mA
Minimum quiescent current		10.0	8.5	8.3	8.0	Min	mA
Power supply rejection	+PSRR	115	90	88	86	Min	dB
	-PSRR	115	90	88	86	Min	
TEMPERATURE							
Specified operating range, T_A		-40 to 85				Typ	°C
Thermal resistance, θ_{JA}	Junction-to-ambient						
8D: SO-8		170				Typ	°C/W
8DDA: SO-8 with PowerPAD		66.6				Typ	°C/W

electrical specifications: $V_S = \pm 5\text{ V}$; $R_F = 250\ \Omega$, $R_L = 1\ \text{k}\Omega$ and $G = +2$ (unless otherwise noted)

PARAMETER	TEST CONDITIONS	THS4601						UNIT
		TYP	OVER TEMPERATURE					
		25°C	25°C	0°C to 70°C	-40°C to 85°C	MIN/MAX		
AC PERFORMANCE								
Small-signal bandwidth	$G = +1, V_O = 20\ \text{mV}_{pp}$	400				Typ	MHz	
	$G = +2, V_O = 40\ \text{mV}_{pp}$	100				Typ	MHz	
	$G = +5, V_O = 100\ \text{mV}_{pp}$	50				Typ	MHz	
	$G = +10, V_O = 200\ \text{mV}_{pp}$	18				Typ	MHz	
Gain-bandwidth product	$G > +10$	180				Typ	MHz	
Bandwidth for 0.1 dB flatness	$G = +2, V_O = 200\ \text{mV}_{pp}$	5				Typ	MHz	
Large-signal bandwidth	$G = +5, V_O = 5\ \text{V}_{pp}$	6				Typ	MHz	
Slew rate, SR	$G = +5, 5\ \text{V Step}$	100				Typ	V/ μs	
Rise/fall time, t_r/t_f	1.0 V Step	8				Typ	ns	
Settling time, t_s	0.01%	$G = +5, V_O = 2\ \text{V Step}$	140			Typ	ns	
	0.1%	$G = +5, V_O = 2\ \text{V Step}$	170			Typ	ns	
Harmonic distortion	$G = +2, f = 1\ \text{MHz}, V_O = 2\ \text{V}_{pp}$							
2 nd Harmonic	$R_L = 100\ \Omega$	-74				Typ	dBc	
	$R_L = 1\ \text{k}\Omega$	-84				Typ		
3 rd Harmonic	$R_L = 100\ \Omega$	-79				Typ	dBc	
	$R_L = 1\ \text{k}\Omega$	-94				Typ		
Input voltage noise, V_n	$f > 10\ \text{kHz}$	5.4				Typ	nV/ $\sqrt{\text{Hz}}$	
Input current noise, I_n	$f > 10\ \text{kHz}$	5.5				Typ	fA/ $\sqrt{\text{Hz}}$	
Differential gain (NTSC and PAL)	$G = +2, R_L = 150\ \Omega$	0.02%				Typ		
Differential phase (NTSC and PAL)	$G = +2, R_L = 150\ \Omega$	0.08				Typ	°	
DC PERFORMANCE								
Open-loop voltage gain	$G = -10, R_L = 1\ \text{k}\Omega$	105	94	92	90	Min	dB	
Input offset voltage, V_{IO}	$V_{CM} = 0\ \text{V}$	1.0	4.0	4.5	5.0	Max	mV	
Average offset voltage drift	$V_{CM} = 0\ \text{V}$			± 10	± 10	Typ	$\mu\text{V}/^\circ\text{C}$	
Input bias current, I_B	$V_{CM} = 0\ \text{V}$	20	100	550	1100	Max	pA	
Average bias current drift	$V_{CM} = 0\ \text{V}$			50	50	Typ	pA/ $^\circ\text{C}$	
Input offset current, I_{IO}	$V_{CM} = 0\ \text{V}$	1	100	200	300	Max	pA	
Average offset current drift	$V_{CM} = 0\ \text{V}$			5	5	Typ	pA/ $^\circ\text{C}$	
INPUT								
Common-mode input range, V_{IC}		± 2.2	2.7 to -2.0	2.6 to -1.9	2.5 to -1.8	Min	V	
Common-mode rejection ratio, CMRR		110	100	95	90	Min	dB	
Input impedance, Z_{id}	Differential	$10^9 \parallel 3.5$				Typ	$\Omega \parallel \text{pF}$	
Input impedance, Z_{ic}	Common-mode	$10^9 \parallel 6.5$				Typ	$\Omega \parallel \text{pF}$	
OUTPUT								
Voltage output swing	$R_L = 1\ \text{k}\Omega$	2.9 to -3.5	2.6 to -3.3	2.5 to -3.2	2.3 to -3.1	Min	V	
Current output, I_O	Sourcing	$R_L = 20\ \Omega$	-65	-48	-48	-47	Min	mA
	Sinking		45	30	30	29	Min	
Closed-loop output impedance, Z_O	$G = +1, f = 1\ \text{MHz}$	0.1				Typ	Ω	

THS4601

SLOS388B – OCTOBER 2001 – REVISED JUNE 2002

electrical specifications: $V_S = \pm 5\text{ V}$; $R_F = 250\ \Omega$, $R_L = 1\ \text{k}\Omega$ and $G = +2$ (unless otherwise noted)
(continued)

PARAMETER	TEST CONDITIONS	THS4601					UNIT
		TYP	OVER TEMPERATURE				
		25°C	25°C	0°C to 70°C	-40°C to 85°C	MIN/MAX	
POWER SUPPLY							
Specified operating voltage		±5	±16.5	±16.5	±16.5	Max	V
Maximum quiescent current		9.6	11.2	11.4	11.7	Max	mA
Minimum quiescent current		9.6	8.2	8.0	7.7	Min	mA
Power supply rejection	+PSRR	110	90	88	86	Min	dB
	-PSRR	110	90	88	86	Min	
TEMPERATURE							
Specified operating range, T_A		-40 to 85				Typ	°C
Thermal resistance, θ_{JA}	Junction-to-ambient						
8D: SO-8		170				Typ	°C/W
8DDA: SO-8 with PowerPAD		67				Typ	°C/W

TYPICAL CHARACTERISTICS
Table of Graphs

	FIGURE
Small-Signal Unity Gain Frequency Response	2
Large-Signal Unity Gain Frequency Response	3
Small-Signal Frequency Response, Gain = +2	4
Small-Signal Frequency Response, Gain = +5	5
Small-Signal Frequency Response, Gain = +10	6
Small-Signal Frequency Response, Gain = +100	7
Open-Loop Gain and Phase vs Frequency	8
Voltage Noise vs Frequency	9
Rejection Ratios vs Frequency	10
Closed-Loop Output Impedance vs Frequency	11
Large-Signal Pulse Response	12
Harmonic Distortion vs Frequency	13
Harmonic Distortion vs Output Voltage Swing	14
Slew Rate vs Output Voltage Step	15
Input Bias Current vs Input Common-Mode Range	16
Common-Mode Rejection Ratio vs Input Common-Mode Range	17
Open-Loop Gain vs Temperature	18
Input Bias Current vs Temperature	19
Input Offset Current vs Temperature	20
Offset Voltage vs Temperature	21
Quiescent Current vs Temperature	22
Output Current vs Temperature	23
Output Voltage Swing vs Temperature	24
Rejection Ratios vs Temperature	25

TYPICAL CHARACTERISTICS

measurement conditions: $T_A = 25^\circ\text{C}$, $R_L = 1\text{ k}\Omega$, $V_S = \pm 15\text{ V}$ (unless otherwise noted)

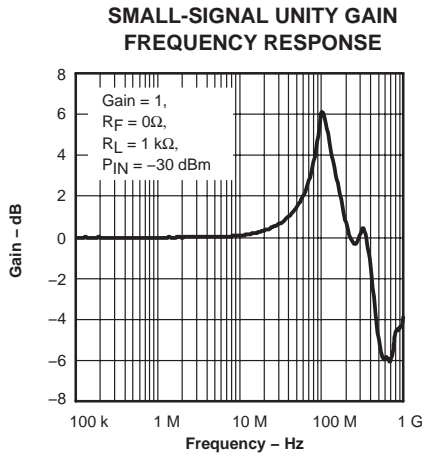

Figure 2

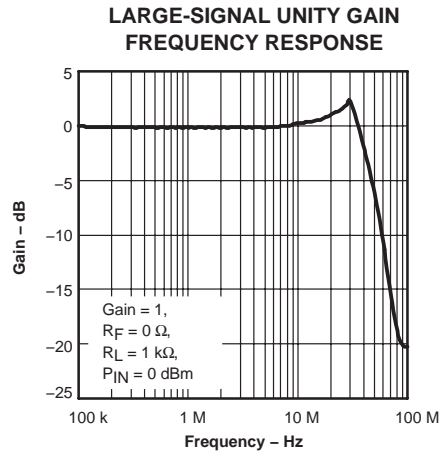

Figure 3

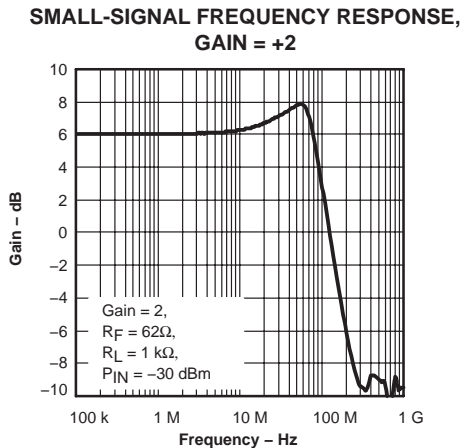

Figure 4

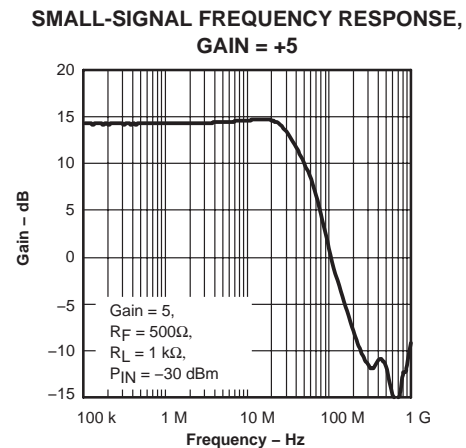

Figure 5

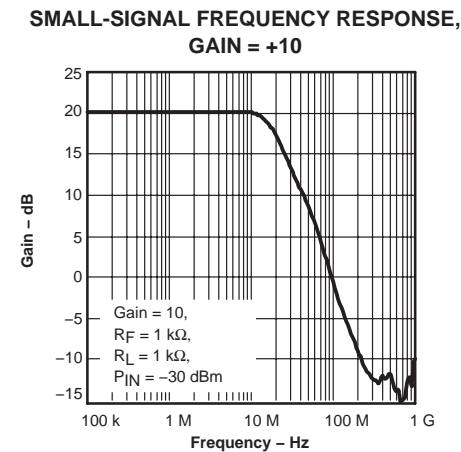

Figure 6

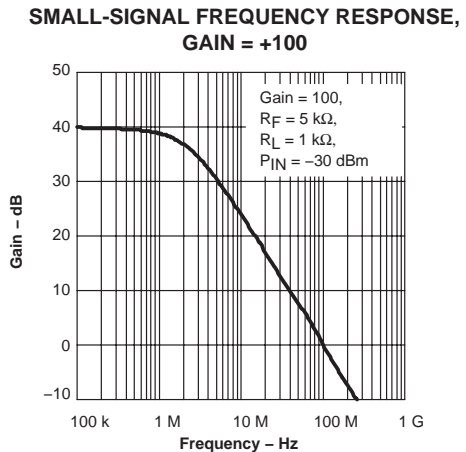

Figure 7

TYPICAL CHARACTERISTICS

measurement conditions: $T_A = 25^\circ\text{C}$, $R_L = 1\text{ k}\Omega$, $V_S = \pm 15\text{ V}$ (unless otherwise noted)

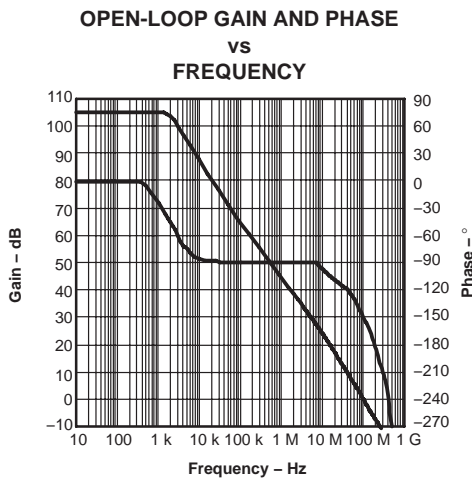

Figure 8

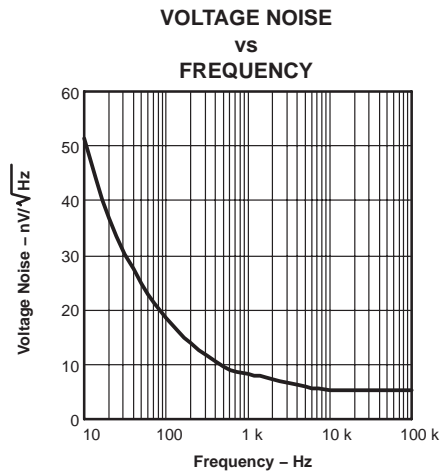

Figure 9

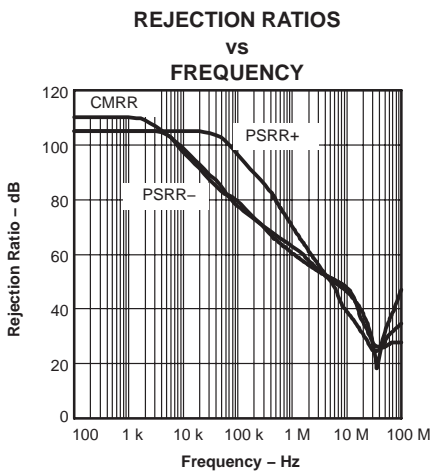

Figure 10

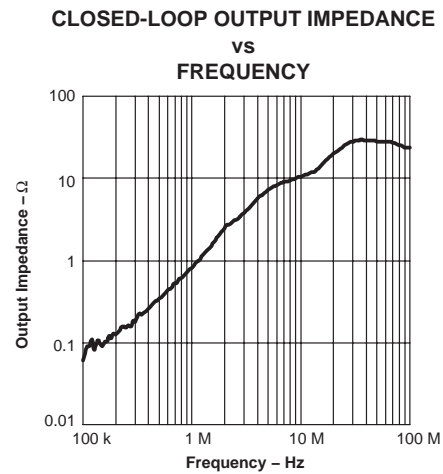

Figure 11

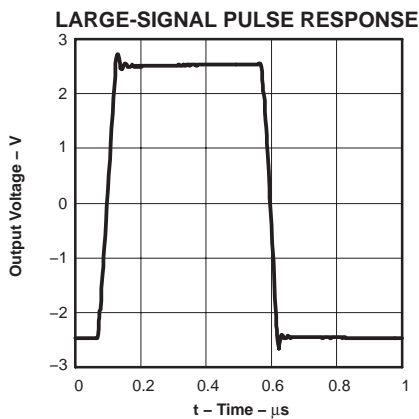

Figure 12

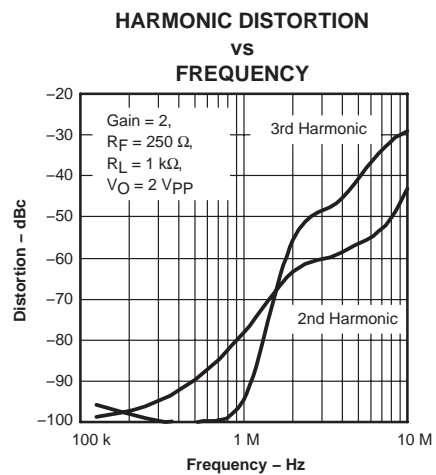
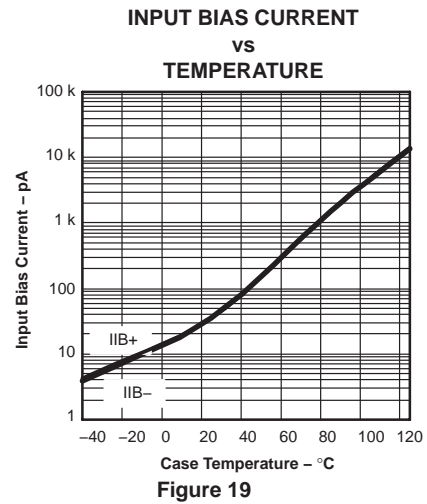
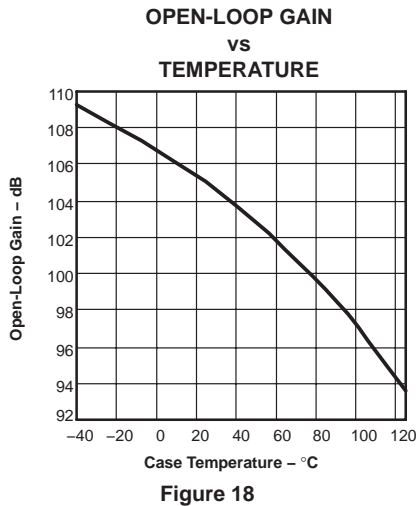
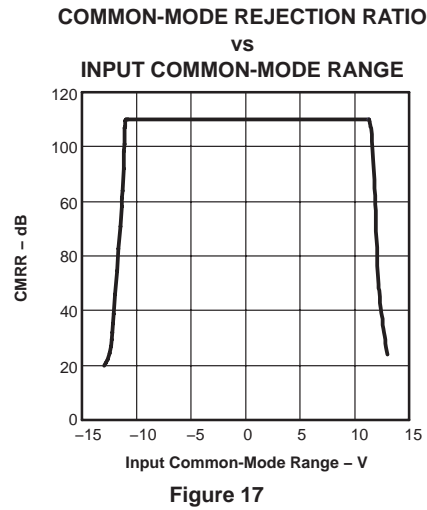
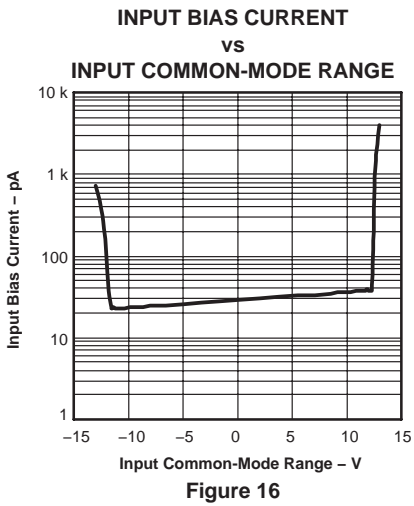
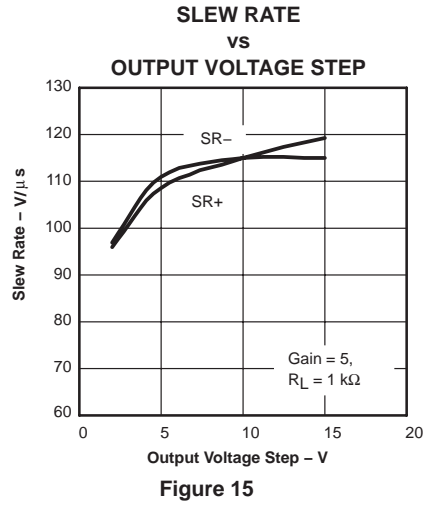
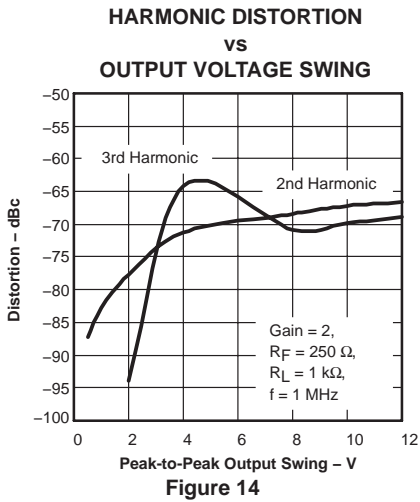

Figure 13

TYPICAL CHARACTERISTICS

measurement conditions: $T_A = 25^\circ\text{C}$, $R_L = 1\text{ k}\Omega$, $V_S = \pm 15\text{ V}$ (unless otherwise noted)



TYPICAL CHARACTERISTICS

measurement conditions: $T_A = 25^\circ\text{C}$, $R_L = 1\text{ k}\Omega$, $V_S = \pm 15\text{ V}$ (unless otherwise noted)

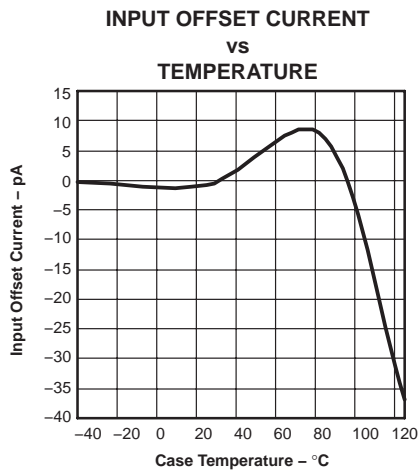

Figure 20

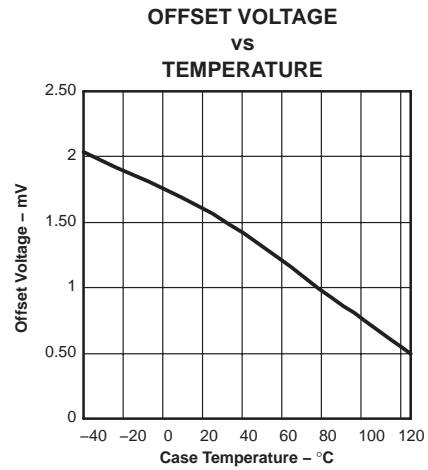

Figure 21

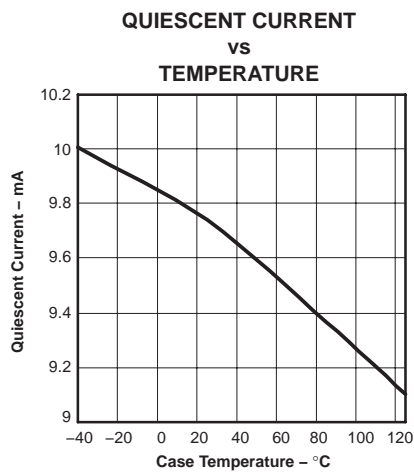

Figure 22

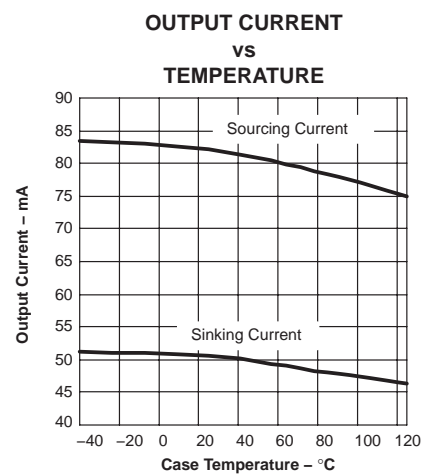

Figure 23

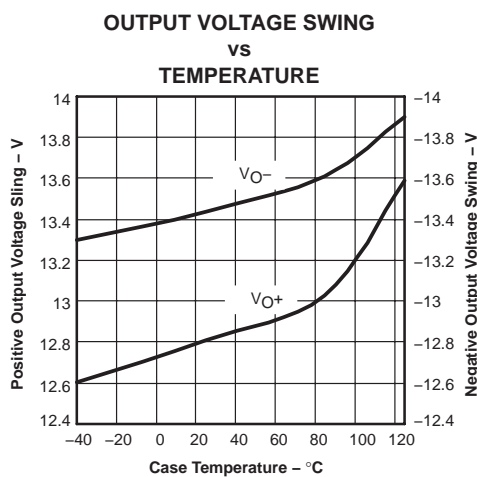

Figure 24

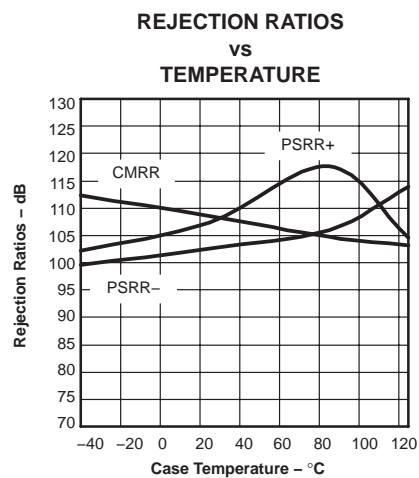

Figure 25

APPLICATION INFORMATION

introduction

The THS4601 is a high-speed, FET-input operational amplifier. The combination of its high frequency capabilities and its DC precision make it a design option for a wide variety of applications, including test and measurement, optical monitoring, transimpedance gain circuits, and high-impedance buffers. The applications section of the data sheet discusses these particular applications in addition to general information about the device and its features.

transimpedance fundamentals

FET-input amplifiers are often used in transimpedance applications because of their extremely high input impedance. A transimpedance block accepts a current as an input and converts this current to a voltage at the output. The high-input impedance associated with FET-input amplifiers minimizes errors in this process caused by the input bias currents, I_{IB} , of the amplifier.

designing the transimpedance circuit

Typically, design of a transimpedance circuit is driven by the characteristics of the current source that provides the input to the gain block. A photodiode is the most common example of a capacitive current source that would interface with a transimpedance gain block. Continuing with the photodiode example, the system designer traditionally chooses a photodiode based on two opposing criteria: speed and sensitivity. Faster photodiodes cause a need for faster gain stages, and more sensitive photodiodes require higher gains in order to develop appreciable signal levels at the output of the gain stage.

These parameters affect the design of the transimpedance circuit in a few ways. First, the speed of the photodiode signal determines the required bandwidth of the gain circuit. However, the required gain, based on the sensitivity of the photodiode, limits the bandwidth of the circuit. Additionally, the larger capacitance associated with a more sensitive signal source also detracts from the achievable speed of the gain block. The dynamic range of the input signal also places requirements on the amplifier’s dynamic range. Knowledge of the source’s output current levels, coupled with a desired voltage swing on the output, dictates the value of the feedback resistor, R_F . The transfer function from input to output is $V_{OUT} = I_{IN}R_F$.

The large gain-bandwidth product of the THS4601 provides the capability for achieving both high transimpedance gain and wide bandwidth simultaneously. In addition, the high power supply rails provide the potential for a very wide dynamic range at the output, allowing for the use of input sources which possess wide dynamic range. The combination of these characteristics makes the THS4601 a design option for systems that require transimpedance amplification of wideband, low-level input signals. A standard transimpedance circuit is shown in Figure 26.

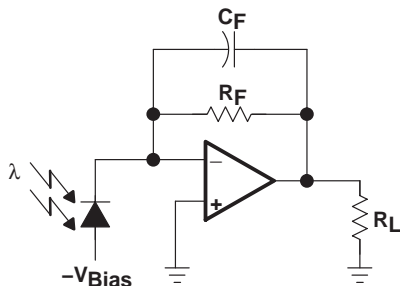

Figure 26. Wideband Photodiode Transimpedance Amplifier

APPLICATION INFORMATION

designing the transimpedance circuit (continued)

As indicated, the current source typically sets the requirements for gain, speed, and dynamic range of the amplifier. For a given amplifier and source combination, achievable performance is dictated by the following parameters: the amplifier's gain-bandwidth product, the amplifier's input capacitance, the source capacitance, the transimpedance gain, the amplifier's slew rate, and the amplifier's output swing. From this information, the optimal performance of a transimpedance circuit using a given amplifier can be determined. Optimal is defined here as providing the required transimpedance gain with a maximally flat frequency response.

For the circuit shown in Figure 26, all but one of the design parameters is known; the feedback capacitor must be determined. Proper selection of the feedback capacitor prevents an unstable design, controls pulse response characteristics, provides maximally flat transimpedance bandwidth, and limits broadband integrated noise. The maximally flat frequency response results with C_F calculated as shown in equation 1, where C_F is the feedback capacitor, R_F is the feedback resistor, C_S is the total source capacitance (including amplifier input capacitance and parasitic capacitance at the inverting node), and GBP is the gain-bandwidth product of the amplifier in hertz.

$$C_F = \frac{\frac{1}{\pi R_F \text{GBP}} + \sqrt{\left(\frac{1}{\pi R_F \text{GBP}}\right)^2 + \frac{4C_S}{\pi R_F \text{GBP}}}}{2} \quad (1)$$

Once the optimal feedback capacitor has been selected, the transimpedance bandwidth can be calculated with equation 2.

$$F_{-3 \text{ dB}} = \sqrt{\frac{\text{GBP}}{2\pi R_F (C_S + C_F)}} \quad (2)$$

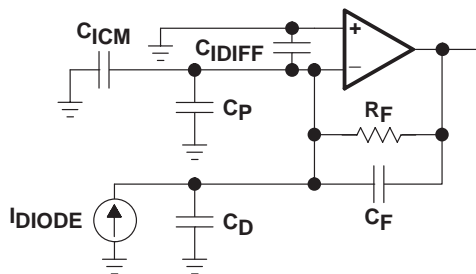

$$C_S = C_{ICM} + C_{IDIFF} + C_P + C_D$$

Where: C_{ICM} is the common-mode input capacitance.
 C_{IDIFF} is the differential input capacitance.
 C_D is the diode capacitance.
 C_P is parasitic capacitance at the inverting node.

NOTE: The total source capacitance is the sum of several distinct capacitances.

Figure 27. Transimpedance Analysis Circuit

APPLICATION INFORMATION

designing the transimpedance circuit (continued)

The feedback capacitor provides a pole in the noise gain of the circuit, counteracting the zero in the noise gain caused by the source capacitance. The pole is set such that the noise gain achieves a 20 dB per decade rate-of-closure with the open-loop gain response of the amplifier, resulting in a stable circuit. As indicated, the formula given provides the feedback capacitance for maximally flat bandwidth. Reduction in the value of the feedback capacitor can increase the signal bandwidth, but this occurs at the expense of peaking in the AC response.

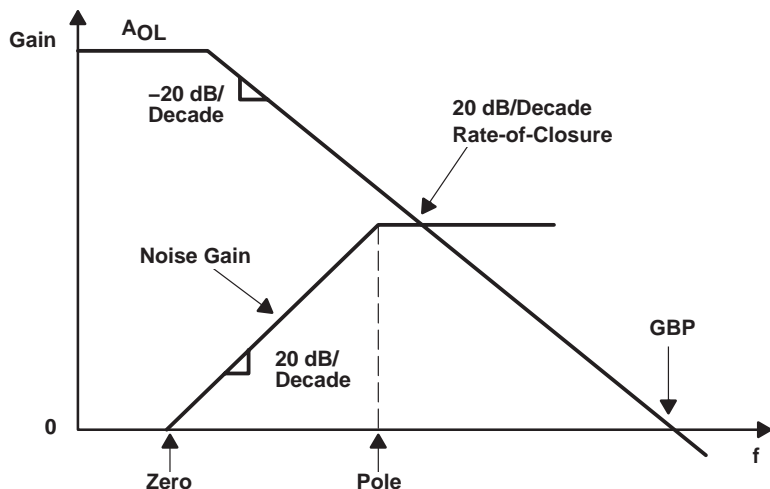

Figure 28. Transimpedance Circuit Bode Plot

The performance of the THS4601 has been measured for a variety of transimpedance gains with a variety of source capacitances. The achievable bandwidths of the various circuit configurations are summarized numerically in the table. The frequency responses are presented in the Figures 27, 28, and 29.

Note that the feedback capacitances do not correspond exactly with the values predicted by the equation. They have been tuned to account for the parasitic capacitance of the feedback resistor (typically 0.2 pF for 0805 surface mount devices) as well as the additional capacitance associated with the PC board. The equation should be used as a starting point for the design, with final values for C_F optimized in the laboratory.

APPLICATION INFORMATION

designing the transimpedance circuit (continued)

Table 1. Transimpedance Performance Summary for Various Configurations

SOURCE CAPACITANCE (pF)	TRANSIMPEDANCE GAIN (Ω)	FEEDBACK CAPACITANCE (pF)	-3 dB FREQUENCY (MHz)
18	10k	2.2	10.4
18	100k	0.6	3.3
18	1M	0	1.1
47	10k	3.3	7.6
47	100k	0.6	2.8
47	1M	0	0.88
100	10k	3.9	5.9
100	100k	1.5	1.3
100	1M	0	0.62
220	10k	5.6	3.8
220	100k	1.8	1.1
220	1M	0.4	0.36

10 k Ω TRANSIMPEDANCE BANDWIDTH FOR VARIOUS SOURCE CAPACITANCES

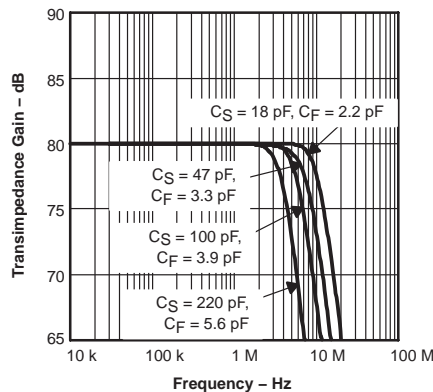

Figure 29

100 k Ω TRANSIMPEDANCE BANDWIDTH FOR VARIOUS SOURCE CAPACITANCES

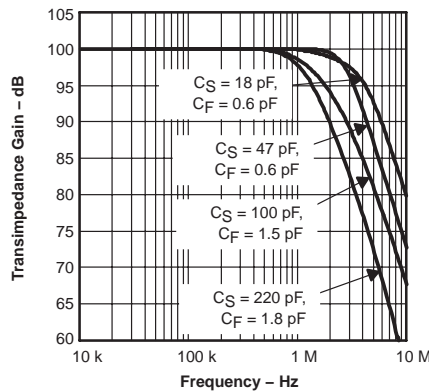

Figure 30

1 M Ω TRANSIMPEDANCE BANDWIDTH FOR VARIOUS SOURCE CAPACITANCES

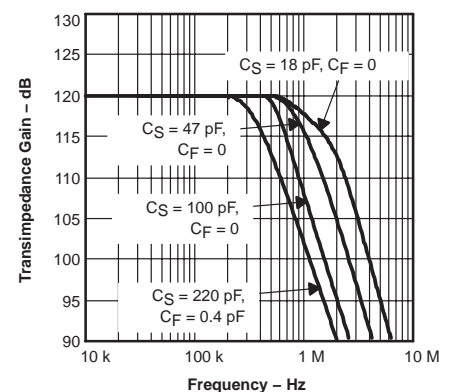

Figure 31

measuring transimpedance bandwidth

While there is no substitute for measuring the performance of a particular circuit under the exact conditions that are used in the application, the complete system environment often makes measurements harder. For transimpedance circuits, it is difficult to measure the frequency response with traditional laboratory equipment because the circuit requires a current as an input rather than a voltage. Also, the capacitance of the current source has a direct effect on the frequency response. A simple interface circuit can be used to emulate a capacitive current source with a network analyzer. With this circuit, transimpedance bandwidth measurements are simplified, making amplifier evaluation easier and faster.

APPLICATION INFORMATION

measuring transimpedance bandwidth (continued)

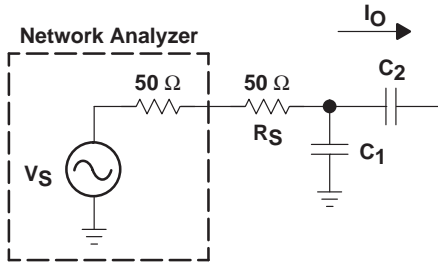

$$\frac{I_O}{V_S} = \frac{1}{2R_S \left(1 + \frac{C_1}{C_2}\right)} \quad (\text{above the pole frequency})$$

NOTE: This interface network creates a capacitive, constant current source from a network analyzer and properly terminates the network analyzer at high frequencies.

Figure 32. Emulating a Capacitive Current Source With a Network Analyzer

The transconductance transfer function of the interface circuit is

$$\frac{I_O}{V_S}(s) = \frac{\frac{s}{2R_S \left(1 + \frac{C_1}{C_2}\right)}}{s + \frac{1}{2R_S(C_1 + C_2)}}$$

This transfer function contains a zero at DC and a pole at $s = \frac{1}{2R_S(C_1 + C_2)}$. The transconductance is

constant at $\frac{1}{2R_S \left(1 + \frac{C_1}{C_2}\right)}$, above the pole frequency, providing a controllable AC current source. This circuit

also properly terminates the network analyzer with 50 Ω at high frequencies. The second requirement for this current source is to provide the desired output impedance, emulating the output impedance of a photodiode or other current source. The output impedance of this circuit is given by

$$Z_O(s) = \frac{C_1 + C_2}{C_1 C_2} \left[\frac{s + \frac{1}{2R_S(C_1 + C_2)}}{s \left(s + \frac{1}{2R_S C_1}\right)} \right]$$

Assuming $C_1 \gg C_2$, the equation reduces to $Z_O \approx \frac{1}{sC_2}$, giving the appearance of a capacitive source at higher frequency.

Capacitor values should be chosen to satisfy two requirements. First, C_2 should represent the anticipated capacitance of the true source. C_1 should then be chosen such that the corner frequency of the transconductance network is much less than the transimpedance bandwidth of the circuit. Choosing this corner frequency properly leads to more accurate measurements of the transimpedance bandwidth. If the interface circuit's corner frequency is too close to the bandwidth of the circuit, determining the power level in the flatband is difficult. A decade or more of flat bandwidth provides a good basis for determining the proper transimpedance bandwidth.

APPLICATION INFORMATION

alternative transimpedance configurations

Other transimpedance configurations are possible. Three possibilities are shown below.

The first configuration is a slight modification of the basic transimpedance circuit. By splitting the feedback resistor, the feedback capacitor value becomes more manageable and easier to control. This type of compensation scheme is useful when the feedback capacitor required in the basic configuration becomes so small that the parasitic effects of the board and components begin to dominate the total feedback capacitance. By reducing the resistance across the capacitor, the capacitor value can be increased. This mitigates the dominance of the parasitic effects.

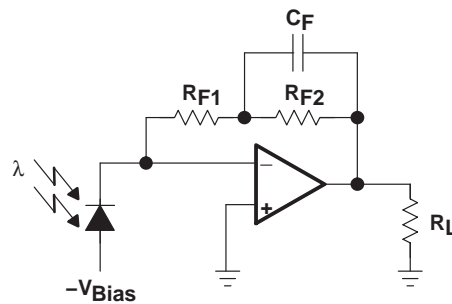

NOTE: Splitting the feedback resistor enables use of a larger, more manageable feedback capacitor.

Figure 33. Alternative Transimpedance Configuration #1

The second configuration uses a resistive T-network to achieve very high transimpedance gains using relatively small resistor values. This topology can be very useful when the desired transimpedance gain exceeds the value of available resistors. The transimpedance gain is given by equation 3.

$$R_{EQ} = R_{F1} \left(1 + \frac{R_{F2}}{R_{F3}} \right) \quad (3)$$

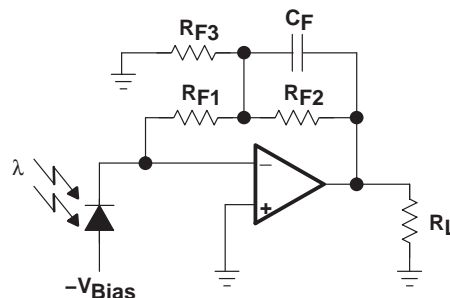

NOTE: A resistive T-network enables high transimpedance gain with reasonable resistor values.

Figure 34. Alternative Transimpedance Configuration #2

APPLICATION INFORMATION

alternative transimpedance configurations (continued)

The third configuration uses a capacitive T-network to achieve fine control of the compensation capacitance. The capacitor C_{F3} can be used to tune the total effective feedback capacitance to a very fine degree. This circuit behaves the same as the basic transimpedance configuration, with the effective C_F given by equation 4.

$$\frac{1}{C_{FEQ}} = \frac{1}{C_{F1}} \left(1 + \frac{C_{F3}}{C_{F2}} \right) \tag{4}$$

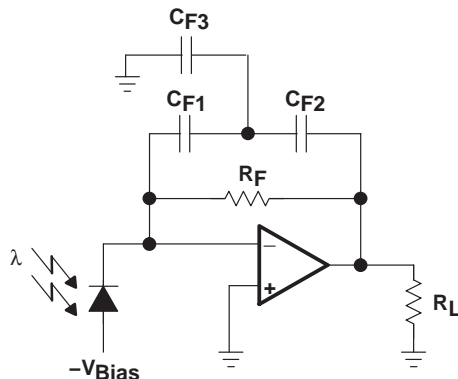

NOTE: A capacitive T-network enables fine control of the effective feedback capacitance using relatively large capacitor values.

Figure 35. Alternative Transimpedance Configuration #3

summary of key decisions in transimpedance design

The following is a quick, simplified process for basic transimpedance circuit design. This process gives a quick start to the design process, though it does ignore some aspects that may be critical to the circuit.

- Step 1:** Determine the capacitance of the source.
- Step 2:** Calculate the total source capacitance, including the amplifier input capacitance, C_{ICM} and C_{IDIFF} .
- Step 3:** Determine the magnitude of the possible current output from the source, including the minimum signal current anticipated and maximum signal current anticipated.
- Step 4:** Choose a feedback resistor value such that the input current levels create the desired output signal voltages, and ensure that the output voltages can accommodate the dynamic range of the input signal.
- Step 5:** Calculate the optimum feedback capacitance using equation 1.
- Step 6:** Calculate the bandwidth given the resulting component values.
- Step 7:** Evaluate the circuit to see if all design goals are satisfied.

APPLICATION INFORMATION

selection of feedback resistors

Feedback resistor selection can have a significant effect on the performance of the THS4601 in a given application, especially in configurations with low closed-loop gain. If the amplifier is configured for unity gain, the output should be directly connected to the inverting input. Any resistance between these two points interacts with the input capacitance of the amplifier and causes an additional pole in the frequency response. For non-unity gain configurations, low resistances are desirable for flat frequency response. However, care must be taken not to load the amplifier too heavily with the feedback network if large output signals are expected. In most cases, a tradeoff will be made between the frequency response characteristics and the loading of the amplifier. For a gain of 2, a 250 Ω feedback resistor is a suitable operating point from both perspectives.

If resistor values are chosen too large, the THS4601 is subject to oscillation problems. For example, an inverting amplifier configuration with a 1-k Ω gain resistor and a 1-k Ω feedback resistor develops an oscillation due to the interaction of the large resistors with the input capacitance. In low gain configurations, avoid feedback resistors this large or anticipate using an external compensation scheme to stabilize the circuit.

overdrive recovery

The THS4601 has an overdrive recovery period when the output is driven close to one power supply rail or the other. The overdrive recovery time period is dependent upon the magnitude of the overdrive and whether the output is driven towards the positive or the negative power supply. The four graphs shown here depict the overdrive recovery time in two cases, an attempted 28 V_{PP} signal on the output and an attempted 30 V_{PP} signal on the output. Note that in both of these cases, the output does not achieve these levels as the output voltage swing is limited to less than these values, but these values are representative of the desired signal swing on the output for the given inputs. As shown in the figures, the recovery period increases as the magnitude of the overdrive increases, with the worst case recovery occurring with the negative rail. The recovery times are summarized in Table 2.

Table 2. Overdrive Recovery Characteristics

VOLTAGE RAIL	IDEAL OUTPUT SWING (V _{PP})	OVERDRIVE RECOVERY TIME (ns)
+V _S	28	320
-V _S	28	340
+V _S	30	540
-V _S	30	680

APPLICATION INFORMATION

overdrive recovery (continued)

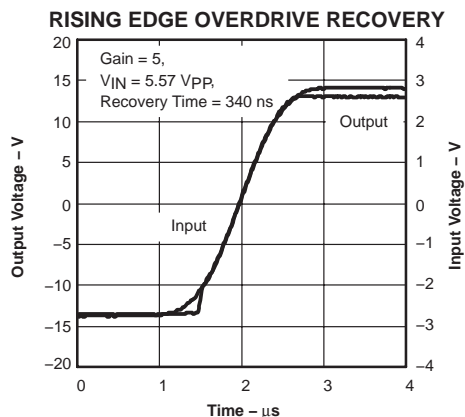

Figure 36

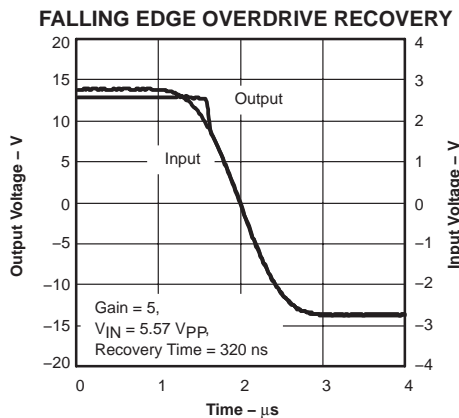

Figure 37

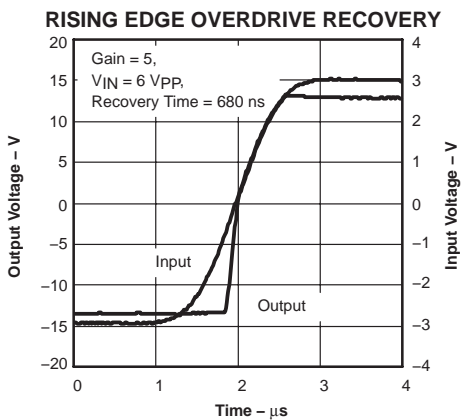

Figure 38

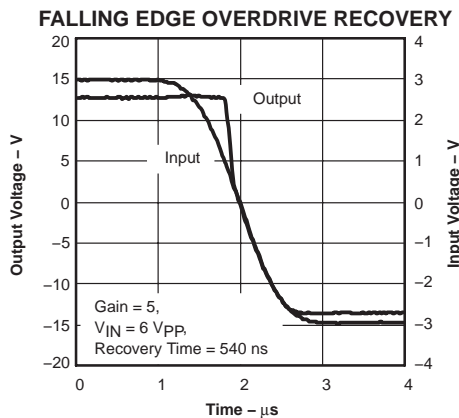

Figure 39

high frequency continuous wave amplification

When presented with high frequency sinusoids in low-gain configurations ($G < 5$), the THS4601 experiences a relatively large differential input voltage between the two input terminals of the amplifier. As this differential input voltage increases, the internal slew-boosting circuitry can cause some transistors in the signal path to enter the cutoff region of operation. As the derivative of the signal changes signs, these transistors suffer from a short recovery time period, generating appreciable levels of distortion. This behavior is depicted in the graph Harmonic Distortion vs Frequency. At 2 MHz with a 2 V_{PP} output signal, the distortion rises significantly. For most high-gain configurations including transimpedance applications, this phenomena is not problematic.

slew rate performance with varying input step amplitude and rise/fall time

Some FET input amplifiers exhibit the peculiar behavior of having a larger slew rate when presented with smaller input voltage steps and slower edge rates due to a change in bias conditions in the input stage of the amplifier under these circumstances. This phenomena is most commonly seen when FET input amplifiers are used as voltage followers. As this behavior is typically undesirable, the THS4601 has been designed to avoid these issues. Larger amplitudes lead to higher slew rates, as would be anticipated, and fast edges do not degrade the slew rate of the device.

APPLICATION INFORMATION

power dissipation and thermal characteristics

The THS4601 does not incorporate automatic thermal shutoff protection, so the designer must take care to ensure that the design does not violate the absolute maximum junction temperature of the device. Failure may result if the absolute maximum junction temperature of 150°C is exceeded.

The thermal characteristics of the device are dictated by the package and the PC board. Maximum power dissipation for a given package can be calculated using the following formula.

$$P_{Dmax} = \frac{T_{max} - T_A}{\theta_{JA}}$$

Where:

P_{Dmax} is the maximum power dissipation (W)

T_{max} is the absolute maximum junction temperature (°C)

T_A is the ambient temperature (°C)

θ_{JA} is the thermal coefficient from the silicon junctions to the ambient air (°C/W)

For systems where heat dissipation is more critical, the THS4601 is offered in an 8-pin SOIC with PowerPAD. The thermal coefficient for the SOIC PowerPAD is substantially improved over the traditional SOIC. Maximum power dissipation levels are depicted in the graph for the two packages. The data for the 8DDA package assumes a board layout that follows the PowerPAD layout guidelines.

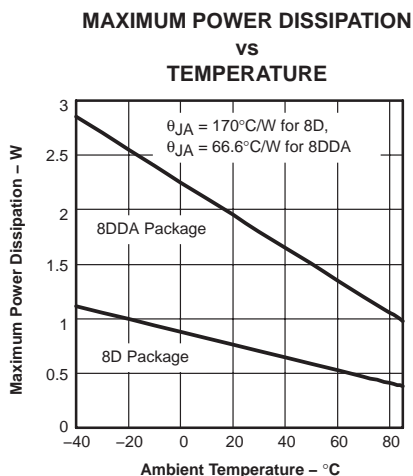

Figure 40

When determining whether or not the device satisfies the maximum power dissipation requirement, it is important to not only consider quiescent power dissipation, but also dynamic power dissipation. Often times, this is difficult to quantify because the signal pattern is inconsistent, but an estimate of the RMS power dissipation can provide visibility into a possible problem.

APPLICATION INFORMATION

PC board layout guidelines

Achieving optimum performance with a high frequency amplifier requires careful attention to board layout parasitics and external component selection. Recommendations that optimize performance include the following.

- Use of a ground plane—It is highly recommended that a ground plane be used on the board to provide all components with a low impedance connection to ground. However, the ground plane should be cleared around the amplifier inputs and outputs to minimize parasitic capacitance. A solid ground plane is recommended wherever possible.
- Proper power supply decoupling—A 6.8 μF tantalum capacitor and a 0.1 μF ceramic capacitor should be used on each power supply node. Good performance is possible if the 6.8 μF capacitor is shared among several amplifiers, but each amplifier should have a dedicated 0.1 μF capacitor for each supply. The 0.1 μF capacitor should be placed as close to the power supply pins as possible. As the distance from the device increases, the trace inductance rises and decreases the effectiveness of the capacitor. A good design has less than 2.5 mm separating the ceramic capacitor and the power supply pin. The tantalum capacitors can be placed significantly further away from the device.
- Avoid sockets—Sockets are not recommended for high-speed amplifiers. The lead inductance associated with the socket pins often leads to stability problems. Direct soldering to a printed-circuit board yields the best performance.
- Minimize trace length and place parts compactly—Shorter traces minimize stray parasitic elements of the design and lead to better high-frequency performance.
- Use of surface mount passive components—Surface mount passive components are recommended due to the extremely low lead inductance and the small component footprint. These characteristics minimize problems with stray series inductance and allow for a more compact circuit layout. Compact layout reduces both parasitic inductance and capacitance in the design.
- Minimize parasitic capacitance on the signal input and output pins—Parasitic capacitance on the input and output pins can degrade high frequency behavior or cause instability in the circuit. Capacitance on the inverting input or the output is a common cause of instability in high performance amplifiers, and capacitance on the noninverting input can react with the source impedance to cause unintentional band-limiting. To reduce unwanted capacitance around these pins, a window should be opened up in the signal/power layers that are underneath those pins. Power and ground planes should otherwise be unbroken.

PowerPAD design considerations

The THS4601 is available in a thermally-enhanced PowerPAD package. This package is constructed using a downset leadframe upon which the die is mounted (see Figure 39). This arrangement results in the lead frame exposed as a thermal pad on the underside of the package. Because this thermal pad has direct thermal contact with the die, excellent thermal performance can be achieved by providing a good thermal path away from the thermal pad.

The PowerPAD package allows for both assembly and thermal management in one manufacturing operation. During the surface-mount solder operation (when the leads are being soldered), the thermal pad can also be soldered to a copper area underneath the package. Through the use of thermal paths within this copper area, heat can be conducted away from the package into either a ground plane or other heat dissipating device. The PowerPAD is electrically insulated from the amplifier circuitry, but connection to the ground plane is recommended due to the high thermal mass typically associated with a ground plane.

The PowerPAD package represents a breakthrough in combining the small area and ease of assembly of surface mount with the, heretofore, awkward mechanical methods of heatsinking.

APPLICATION INFORMATION

PowerPAD design considerations (continued)

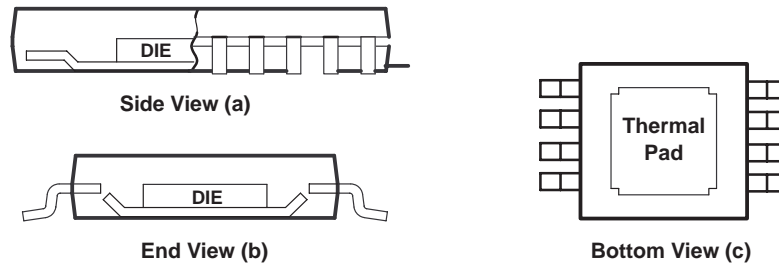

NOTE A: The thermal pad is electrically isolated from all terminals in the package.

Figure 41. Views of Thermally Enhanced Package

Although there are many ways to properly heatsink the PowerPAD package, the following steps illustrate the recommended approach.

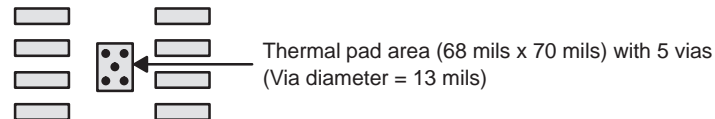

Figure 42. PowerPAD PCB Etch and Via Pattern

PowerPAD PCB LAYOUT CONSIDERATIONS

1. Prepare the PCB with a top side etch pattern as shown in Figure 42. There should be etch for the leads as well as etch for the thermal pad.
2. Place five vias in the area of the thermal pad. These holes should be 13 mils in diameter. Keep them small so that solder wicking through the holes does not occur during reflow.
3. Additional vias may be placed anywhere along the thermal plane outside of the thermal pad area. This helps dissipate the heat generated by the IC. These additional vias may be larger than the 13-mil diameter vias directly under the thermal pad. Larger vias are permissible here because they are not susceptible to solder wicking as the vias underneath the device.
4. Connect all vias to the internal ground plane for best thermal characteristics
5. When connecting these holes to the ground plane, do not use the typical web or spoke via connection methodology. Web connections have a high thermal resistance connection that is useful for slowing the heat transfer during soldering operations. This makes the soldering of vias that have plane connections easier. In this application, however, low thermal resistance is desired for the most efficient heat transfer. Therefore, the holes under the PowerPAD package should make their connection to the internal ground plane with a complete connection around the entire circumference of the plated-through hole.
6. The top-side solder mask should leave the terminals of the package and the thermal pad area with its five holes exposed. The bottom-side solder mask should cover the five holes of the thermal pad area. This prevents solder from being pulled away from the thermal pad area during the reflow process.
7. Apply solder paste to the exposed thermal pad area and all of the IC terminals.
8. With these preparatory steps in place, the IC is simply placed in position and run through the solder reflow operation as any standard surface-mount component. This results in a part that is properly installed.

APPLICATION INFORMATION

evaluation module and applications support

An evaluation board is available for quick laboratory verification of performance. An evaluation module can be ordered from Texas Instruments' web site (www.ti.com) or from your local TI sales representative. Applications support is also available for designers. The Product Information Center (PIC) can put designers in touch with applications engineers at Texas Instruments. The PIC be contacted via the web site as well.

additional reference material

- *PowerPAD Made Easy*, application brief, Texas Instruments Literature Number SLMA004.
- *PowerPAD Thermally Enhanced Package*, technical brief, Texas Instruments Literature Number SLMA002.
- *Noise Analysis of FET Transimpedance Amplifiers*, application bulletin, Texas Instruments Literature Number SBOA060.
- *Tame Photodiodes With Op Amp Bootstrap*, application bulletin, Texas Instruments Literature Number SBBA002.
- *Designing Photodiode Amplifier Circuits With OPA128*, application bulletin, Texas Instruments Literature Number SBOA061.
- *Photodiode Monitoring With Op Amps*, application bulletin, Texas Instruments Literature Number SBOA035.
- *Comparison of Noise Performance Between a FET Transimpedance Amplifier and a Switched Integrator*, Application Bulletin, Texas Instruments Literature Number SBOA034.

PACKAGING INFORMATION

Orderable Device	Status (1)	Package Type	Package Drawing	Pins	Package Qty	Eco Plan (2)	Lead/Ball Finish (6)	MSL Peak Temp (3)	Op Temp (°C)	Device Marking (4/5)	Samples
THS4601CD	ACTIVE	SOIC	D	8	75	Green (RoHS & no Sb/Br)	CU NIPDAU	Level-1-260C-UNLIM	0 to 70	4601C	Samples
THS4601ID	ACTIVE	SOIC	D	8	75	Green (RoHS & no Sb/Br)	CU NIPDAU	Level-1-260C-UNLIM	-40 to 85	4601I	Samples
THS4601IDDA	ACTIVE	SO PowerPAD	DDA	8	75	Green (RoHS & no Sb/Br)	CU SN	Level-1-260C-UNLIM	-40 to 85	4601I	Samples
THS4601IDDAG3	ACTIVE	SO PowerPAD	DDA	8	75	Green (RoHS & no Sb/Br)	CU SN	Level-1-260C-UNLIM	-40 to 85	4601I	Samples
THS4601IDG4	ACTIVE	SOIC	D	8	75	Green (RoHS & no Sb/Br)	CU NIPDAU	Level-1-260C-UNLIM	-40 to 85	4601I	Samples

(1) The marketing status values are defined as follows:

ACTIVE: Product device recommended for new designs.

LIFEBUY: TI has announced that the device will be discontinued, and a lifetime-buy period is in effect.

NRND: Not recommended for new designs. Device is in production to support existing customers, but TI does not recommend using this part in a new design.

PREVIEW: Device has been announced but is not in production. Samples may or may not be available.

OBSOLETE: TI has discontinued the production of the device.

(2) Eco Plan - The planned eco-friendly classification: Pb-Free (RoHS), Pb-Free (RoHS Exempt), or Green (RoHS & no Sb/Br) - please check <http://www.ti.com/productcontent> for the latest availability information and additional product content details.

TBD: The Pb-Free/Green conversion plan has not been defined.

Pb-Free (RoHS): TI's terms "Lead-Free" or "Pb-Free" mean semiconductor products that are compatible with the current RoHS requirements for all 6 substances, including the requirement that lead not exceed 0.1% by weight in homogeneous materials. Where designed to be soldered at high temperatures, TI Pb-Free products are suitable for use in specified lead-free processes.

Pb-Free (RoHS Exempt): This component has a RoHS exemption for either 1) lead-based flip-chip solder bumps used between the die and package, or 2) lead-based die adhesive used between the die and leadframe. The component is otherwise considered Pb-Free (RoHS compatible) as defined above.

Green (RoHS & no Sb/Br): TI defines "Green" to mean Pb-Free (RoHS compatible), and free of Bromine (Br) and Antimony (Sb) based flame retardants (Br or Sb do not exceed 0.1% by weight in homogeneous material)

(3) MSL, Peak Temp. - The Moisture Sensitivity Level rating according to the JEDEC industry standard classifications, and peak solder temperature.

(4) There may be additional marking, which relates to the logo, the lot trace code information, or the environmental category on the device.

(5) Multiple Device Markings will be inside parentheses. Only one Device Marking contained in parentheses and separated by a "~" will appear on a device. If a line is indented then it is a continuation of the previous line and the two combined represent the entire Device Marking for that device.

⁽⁶⁾ Lead/Ball Finish - Orderable Devices may have multiple material finish options. Finish options are separated by a vertical ruled line. Lead/Ball Finish values may wrap to two lines if the finish value exceeds the maximum column width.

Important Information and Disclaimer:The information provided on this page represents TI's knowledge and belief as of the date that it is provided. TI bases its knowledge and belief on information provided by third parties, and makes no representation or warranty as to the accuracy of such information. Efforts are underway to better integrate information from third parties. TI has taken and continues to take reasonable steps to provide representative and accurate information but may not have conducted destructive testing or chemical analysis on incoming materials and chemicals. TI and TI suppliers consider certain information to be proprietary, and thus CAS numbers and other limited information may not be available for release.

In no event shall TI's liability arising out of such information exceed the total purchase price of the TI part(s) at issue in this document sold by TI to Customer on an annual basis.



Images above are just a representation of the package family, actual package may vary.
Refer to the product data sheet for package details.

EXAMPLE STENCIL DESIGN

DDA0008B

PowerPAD™ SOIC - 1.7 mm max height

PLASTIC SMALL OUTLINE



SOLDER PASTE EXAMPLE
 EXPOSED PAD
 100% PRINTED SOLDER COVERAGE BY AREA
 SCALE:10X

STENCIL THICKNESS	SOLDER STENCIL OPENING
0.1	3.03 X 3.80
0.125	2.71 X 3.40 (SHOWN)
0.150	2.47 X 3.10
0.175	2.29 X 2.87

4214849/A 08/2016

NOTES: (continued)

11. Laser cutting apertures with trapezoidal walls and rounded corners may offer better paste release. IPC-7525 may have alternate design recommendations.
12. Board assembly site may have different recommendations for stencil design.

D (R-PDSO-G8)

PLASTIC SMALL OUTLINE



4040047-3/M 06/11

D (R-PDSO-G8)

PLASTIC SMALL OUTLINE



- NOTES:
- A. All linear dimensions are in millimeters.
 - B. This drawing is subject to change without notice.
 - C. Publication IPC-7351 is recommended for alternate designs.
 - D. Laser cutting apertures with trapezoidal walls and also rounding corners will offer better paste release. Customers should contact their board assembly site for stencil design recommendations. Refer to IPC-7525 for other stencil recommendations.
 - E. Customers should contact their board fabrication site for solder mask tolerances between and around signal pads.

IMPORTANT NOTICE

Texas Instruments Incorporated (TI) reserves the right to make corrections, enhancements, improvements and other changes to its semiconductor products and services per JESD46, latest issue, and to discontinue any product or service per JESD48, latest issue. Buyers should obtain the latest relevant information before placing orders and should verify that such information is current and complete.

TI's published terms of sale for semiconductor products (<http://www.ti.com/sc/docs/stdterms.htm>) apply to the sale of packaged integrated circuit products that TI has qualified and released to market. Additional terms may apply to the use or sale of other types of TI products and services.

Reproduction of significant portions of TI information in TI data sheets is permissible only if reproduction is without alteration and is accompanied by all associated warranties, conditions, limitations, and notices. TI is not responsible or liable for such reproduced documentation. Information of third parties may be subject to additional restrictions. Resale of TI products or services with statements different from or beyond the parameters stated by TI for that product or service voids all express and any implied warranties for the associated TI product or service and is an unfair and deceptive business practice. TI is not responsible or liable for any such statements.

Buyers and others who are developing systems that incorporate TI products (collectively, "Designers") understand and agree that Designers remain responsible for using their independent analysis, evaluation and judgment in designing their applications and that Designers have full and exclusive responsibility to assure the safety of Designers' applications and compliance of their applications (and of all TI products used in or for Designers' applications) with all applicable regulations, laws and other applicable requirements. Designer represents that, with respect to their applications, Designer has all the necessary expertise to create and implement safeguards that (1) anticipate dangerous consequences of failures, (2) monitor failures and their consequences, and (3) lessen the likelihood of failures that might cause harm and take appropriate actions. Designer agrees that prior to using or distributing any applications that include TI products, Designer will thoroughly test such applications and the functionality of such TI products as used in such applications.

TI's provision of technical, application or other design advice, quality characterization, reliability data or other services or information, including, but not limited to, reference designs and materials relating to evaluation modules, (collectively, "TI Resources") are intended to assist designers who are developing applications that incorporate TI products; by downloading, accessing or using TI Resources in any way, Designer (individually or, if Designer is acting on behalf of a company, Designer's company) agrees to use any particular TI Resource solely for this purpose and subject to the terms of this Notice.

TI's provision of TI Resources does not expand or otherwise alter TI's applicable published warranties or warranty disclaimers for TI products, and no additional obligations or liabilities arise from TI providing such TI Resources. TI reserves the right to make corrections, enhancements, improvements and other changes to its TI Resources. TI has not conducted any testing other than that specifically described in the published documentation for a particular TI Resource.

Designer is authorized to use, copy and modify any individual TI Resource only in connection with the development of applications that include the TI product(s) identified in such TI Resource. NO OTHER LICENSE, EXPRESS OR IMPLIED, BY ESTOPPEL OR OTHERWISE TO ANY OTHER TI INTELLECTUAL PROPERTY RIGHT, AND NO LICENSE TO ANY TECHNOLOGY OR INTELLECTUAL PROPERTY RIGHT OF TI OR ANY THIRD PARTY IS GRANTED HEREIN, including but not limited to any patent right, copyright, mask work right, or other intellectual property right relating to any combination, machine, or process in which TI products or services are used. Information regarding or referencing third-party products or services does not constitute a license to use such products or services, or a warranty or endorsement thereof. Use of TI Resources may require a license from a third party under the patents or other intellectual property of the third party, or a license from TI under the patents or other intellectual property of TI.

TI RESOURCES ARE PROVIDED "AS IS" AND WITH ALL FAULTS. TI DISCLAIMS ALL OTHER WARRANTIES OR REPRESENTATIONS, EXPRESS OR IMPLIED, REGARDING RESOURCES OR USE THEREOF, INCLUDING BUT NOT LIMITED TO ACCURACY OR COMPLETENESS, TITLE, ANY EPIDEMIC FAILURE WARRANTY AND ANY IMPLIED WARRANTIES OF MERCHANTABILITY, FITNESS FOR A PARTICULAR PURPOSE, AND NON-INFRINGEMENT OF ANY THIRD PARTY INTELLECTUAL PROPERTY RIGHTS. TI SHALL NOT BE LIABLE FOR AND SHALL NOT DEFEND OR INDEMNIFY DESIGNER AGAINST ANY CLAIM, INCLUDING BUT NOT LIMITED TO ANY INFRINGEMENT CLAIM THAT RELATES TO OR IS BASED ON ANY COMBINATION OF PRODUCTS EVEN IF DESCRIBED IN TI RESOURCES OR OTHERWISE. IN NO EVENT SHALL TI BE LIABLE FOR ANY ACTUAL, DIRECT, SPECIAL, COLLATERAL, INDIRECT, PUNITIVE, INCIDENTAL, CONSEQUENTIAL OR EXEMPLARY DAMAGES IN CONNECTION WITH OR ARISING OUT OF TI RESOURCES OR USE THEREOF, AND REGARDLESS OF WHETHER TI HAS BEEN ADVISED OF THE POSSIBILITY OF SUCH DAMAGES.

Unless TI has explicitly designated an individual product as meeting the requirements of a particular industry standard (e.g., ISO/TS 16949 and ISO 26262), TI is not responsible for any failure to meet such industry standard requirements.

Where TI specifically promotes products as facilitating functional safety or as compliant with industry functional safety standards, such products are intended to help enable customers to design and create their own applications that meet applicable functional safety standards and requirements. Using products in an application does not by itself establish any safety features in the application. Designers must ensure compliance with safety-related requirements and standards applicable to their applications. Designer may not use any TI products in life-critical medical equipment unless authorized officers of the parties have executed a special contract specifically governing such use. Life-critical medical equipment is medical equipment where failure of such equipment would cause serious bodily injury or death (e.g., life support, pacemakers, defibrillators, heart pumps, neurostimulators, and implantables). Such equipment includes, without limitation, all medical devices identified by the U.S. Food and Drug Administration as Class III devices and equivalent classifications outside the U.S.

TI may expressly designate certain products as completing a particular qualification (e.g., Q100, Military Grade, or Enhanced Product). Designers agree that it has the necessary expertise to select the product with the appropriate qualification designation for their applications and that proper product selection is at Designers' own risk. Designers are solely responsible for compliance with all legal and regulatory requirements in connection with such selection.

Designer will fully indemnify TI and its representatives against any damages, costs, losses, and/or liabilities arising out of Designer's non-compliance with the terms and provisions of this Notice.